

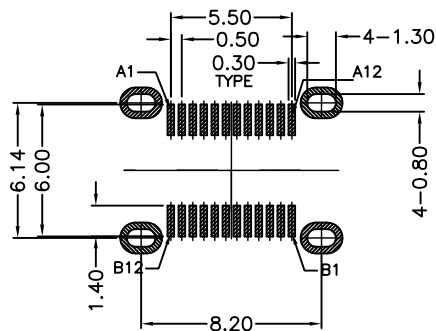

REV.	DESCRIPTION	NAME	DATE
A	NEWS ISSUE		

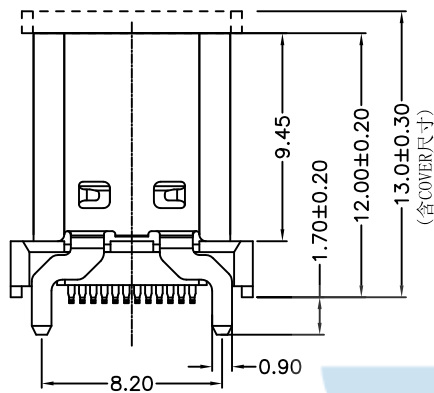

- Contact Resistance: 40mOHM Max.;
- Dielectric Withstanding Voltage: 100V AC For 1 Minute;
- Insulation Resistance: 100M OHM Min.;
- Mating And Unmating Force:
Mating Force: 5~20N
Unmating Force: 8~20N;
6~20N AFTER TEST;
- Durability: 10000 Cycles;

RECOMMEND P.C.B LAYOUT (COMPONENT SIDE)

TOLERANCE FOR PCB LAYOUT IS ± 0.05

KEEP OUT AREA

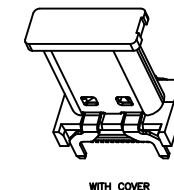
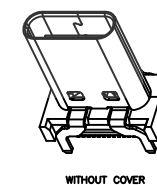
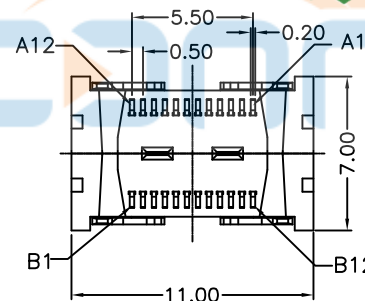
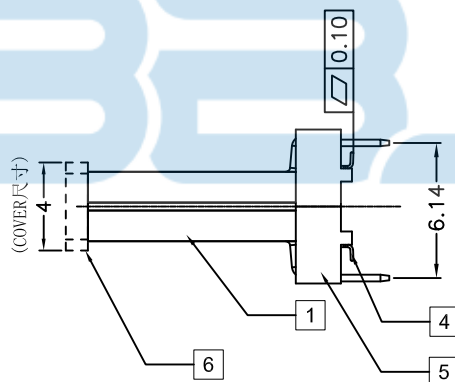
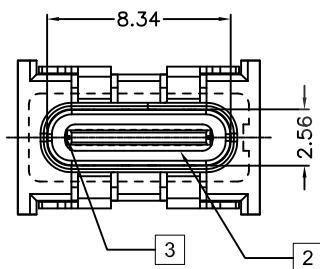

Item	Title	Material	Dispose	Q'TY
1	Shell	SUS304	Ni:30u" Min.	1PCS
2	GND Plate	SUS301		2PCS
3	Mid Plate	SUS301		1PCS
4	Contact	C7025	Mating Area: GOLD FLASH Solder Tails: Matt Tin	2PCS
5	InsertMolding	LCP E6808	UL 94V-0 Black	1PCS
6	COVER	LCP E6808	UL 94V-0 Black	1PCS

USB TYPE-C PIN ASSIGNMENTS

PIN NUMBER	SIGNAL NAME	PIN NUMBER	SIGNAL NAME
A1	GND	B12	GND
A2	TX1+	B11	RX1+
A3	TX1-	B10	RX1-
A4	Vbus	B9	Vbus
A5	CC1	B8	SBU2
A6	D+	B7	D-
A7	D-	B6	D+
A8	SBU1	B5	CC2
A9	Vbus	B4	Vbus
A10	RX2-	B3	TX2-
A11	RX2+	B2	TX2+
A12	GND	B1	GND

TOLERANCE UNSPECIFIED

X. ± 0.35 X* ± 2°
.X ± 0.25 .X* ± 1.5°
.XX ± 0.15
.XXX ± 0.10



TITLE: TYPE-C 24P 母座 直立式 H=12.0

DRAWN/ DATE	设计 HMY	SIZE: A4	UNIT: MM.	PART. NO:	UC. 01. 62-1W-0004
CHECKED/ DATE	审核 LYX	SCALE: 1:1	PROJECTION		REV.: 版本
APPROVED/ DATE	核准 LJP	DWG. PATH	0470-1	SHEET: 页码	

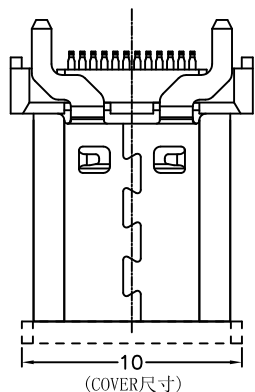



REV.	DESCRIPTION	NAME	DATE
A	NEWS ISSUE		

AROUND THE OUTER PERIPHERY IN A TURE.
WEEDING THE COVER TAPE.

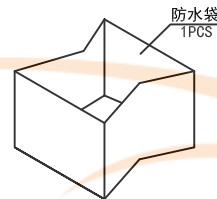
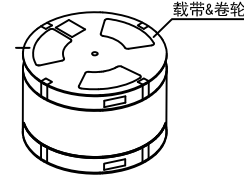
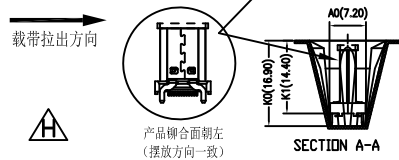
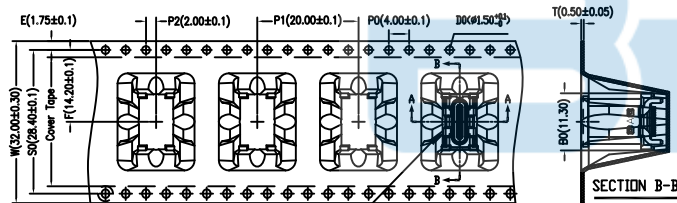
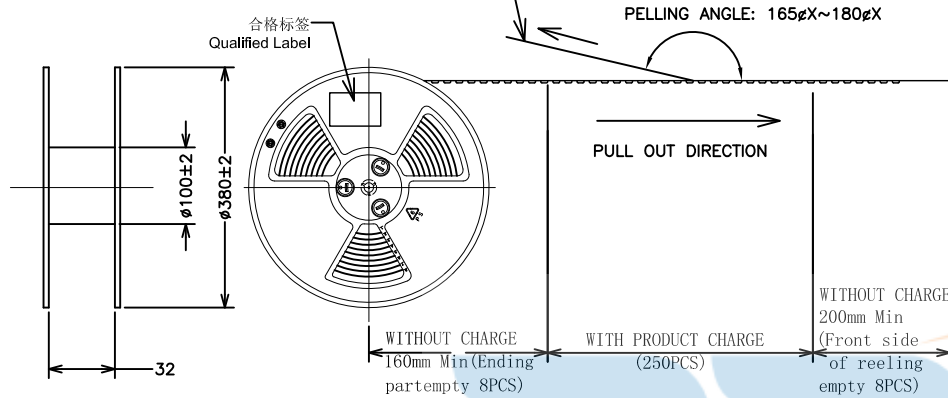

在装入产品的
防水袋中放置2
包干燥剂

产品规格		
Product spec.		/
包装容量	个 / 卷	250
	Pcs/Reel	
QTY	卷 / 箱	8
	Reel/Ctos.	
重量	个 / 箱	2000
	Pcs/Ctos.	
Weigh (Kg)	净重	/kg
	N. W.	
	毛重	/kg
	G. W.	

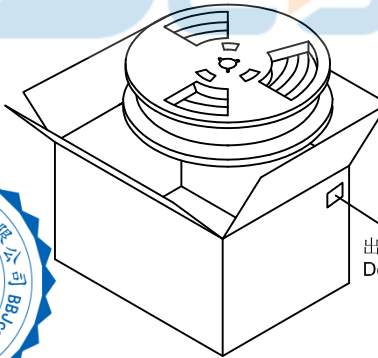

NO.	包材名称 Items	包材料号 Item no	用量 Usage	通用类别 Series	备注 / Remark
①	纸箱 Carton		1	广东省外,K=K	400*400*310mm
②	PE Bag		2		600*600*0.05mm
③	carrier		8		W=32mm PET 透明L=5.32M
④	载带 Carrier				W=25.5MM, 200m/r透明色
⑤	塑胶卷轴 Plastic Reel		8		φ380mm, W=37mm
⑥	干燥剂 Desiccant		4		
⑦	环保标签 RoHS Label		9		
⑧	合格标签 Qualified Label		8		80*35mm
⑨	出货标签 Delivery Label		1		80*50mm

包装规范说明:

- 如图示首先CARRIER TAPE (载带) 需先预留8PCS空格后方可置入成品,并附COVER TPAE(上带)覆盖于上,再配合带装机自动卷绕于REEL(塑胶卷轴)收料。
- 在定量包装完成后,前端CARRIER TAPE亦需预留8PCS空格,而COVER TPAE配合CARRIER TYPE长度覆盖后,并须再超出200mm以上,最后以胶纸贴固,并于REEL盖上方贴好标签。
- 注意:COVER TAPE不可浮起或有贴附不顺,歪斜及成品放置方向错误的现象。
- 在纸箱内左右,前后侧各放入一块三角卡板,每个PE袋中装入8个REEL盘,并在PE袋中放入2PCS干燥剂,用胶带封好,在每个纸箱内装入8PCS卷盘,共1叠,盖上箱盖后以胶带封箱,于侧位置贴好标签。
- 零箱部分, 出货时须用缓冲物填满。

TOLERANCE UNSPECIFIED	
X. ± 0.35	X° ± 2°
.X ± 0.25	.X° ± 1.5°
.XX ± 0.15	
.XXX ± 0.10	

深圳市步步精科技有限公司

TITLE: TYPE-C 24P 母座 直立式 H=12.0

DRAWN/ DATE	设计 HMY	SIZE: A4	UNIT: MM.	PART. NO:	UC. 01. 62-1W-0004
CHECKED/ DATE	审核 LYX	SCALE: 1:1	PROJECTION	REV.:	版本
APPROVED/ DATE	核准 LJP	DWG. PATH		0470-1	SHEET: 页码