

REV.	ECN NO	CONTENT	DATE	ENGINEER
A0			2023 20/04	

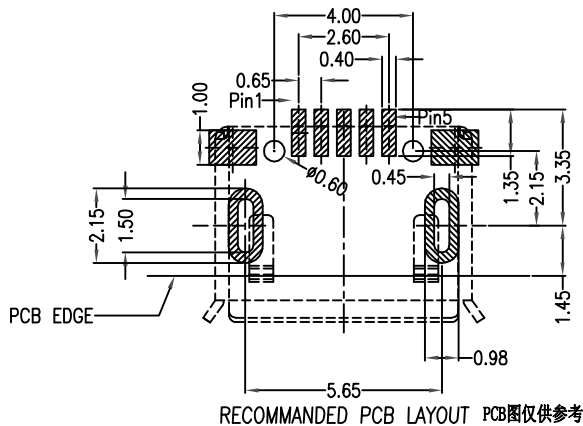
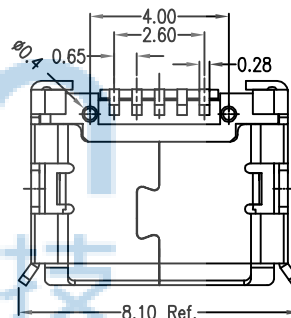
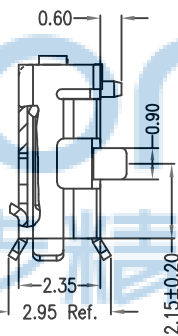
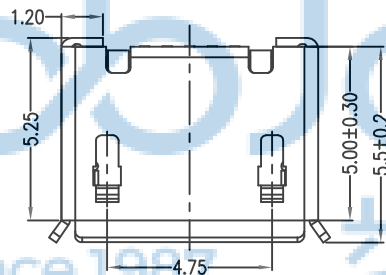
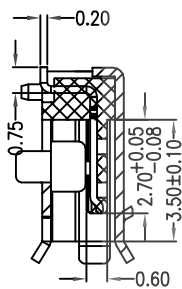
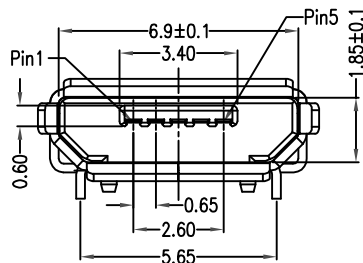
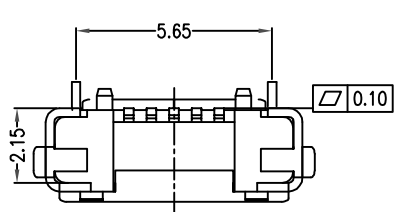

Note:

1. Material:

- 1.1 Housing: High temperature thermoplastic with g.f,UL94v-0 LCP
- 1.2 Contact: copper alloy,t=0.20mm 接触区镀金1u
- 1.3 Shell: c2680

2. Specification:

- 2.1 Current rating:1,5PIN 1A Max/2,3,4PIN 1A Max.
- 2.2 Dielectric withstanding voltage: 100 V(ac) for 1 min.
- 2.3 Contact resistance: 30 mΩ Max.
- 2.4 Insulation resistance: 100 MΩ Min.
- 2.5 Total mating force: 3.57 Kg Max.
- 2.6 Total unmating force: 1.0 Kg Min.
- 2.7 Temperature range: -30°C~80°C



THIS DOCUMENT IS THE SOLE PROPERTY OF BBJconn Technology Co.,Ltd. Corporation AND SHOULD NOT BE USED IN WHOLE OR IN PART WITHOUT PRIOR WRITTEN PERMISSION.		深圳市步步精科技有限公司	
.X: ±0.38 .XX: ±0.25 .XXX: ±0.13		X': ±3" X'': ±2" XX': ±1"	
APPD.	JM_Zheng	23/05'02	NAME: MICRO-5P内插有柱雾锡L=5.5脚距5.65卷边铜壳
CHKD.	LYX	23/05'02	PJ. NO.: MC.01.11-11-1001
DR.	SGF	23/05'02	SIZE: A4 DRW NO.:
PDWG.NO: 0113-1		FINISH: SEE NOTES MAT'L.: SEE NOTES	
		SCALE: N/A REV.: A3 UNIT: mm PAGE: 1/1	

REV.	ECN NO	CONTENT	DATE	ENGINEER
A0			2023 20/04	

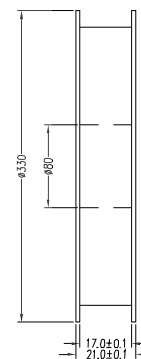
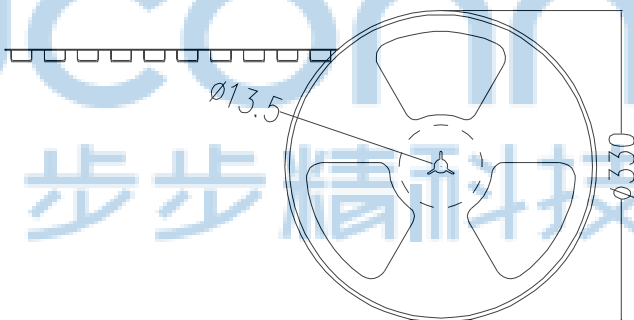
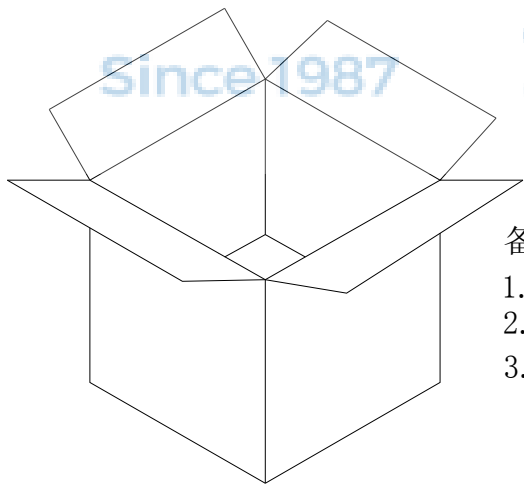
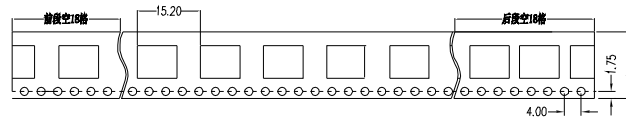
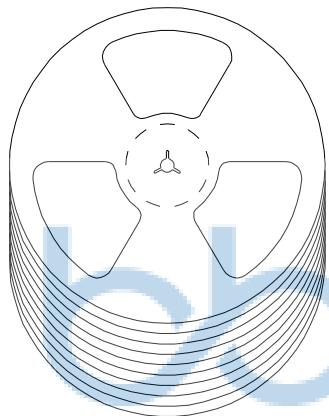

1000 /PCS盘

备注:

1. 包装数量: 1000 /PCS/盘, 10盘/箱或15盘/箱。
2. 包装袋长度: 每盘前后各空10-20个空格, 中间包装。
3. 材质:
载体: 聚丙烯 (PS), 阻抗 $10^{6-9} \Omega$
上带: 聚乙烯 (PET), 阻抗 $10^{6-11} \Omega$
卷盘: 聚苯乙烯。

纸箱规格: 345*345*23MM

纸箱规格: 345*345*35MM



THIS DOCUMENT IS THE SOLE PROPERTY OF BBJconn Technology Co.,Ltd. Corporation AND SHOULD NOT BE USED IN WHOLE OR IN PART WITHOUT PRIOR WRITTEN PERMISSION.		深圳市步步精科技有限公司	
PDWG.NO: 0113-1		APPD. JM_Zheng 23/05'02 CHKD. LYX 23/05'02 DR. SGF 23/05'02	NAME: MICRO-5P内插有柱雾锡L=5.5脚距5.65卷边铜壳 PJ. NO.: MC.01.11-11-1001 SIZE: A4 DRW NO.: FINISH: SEE NOTES MAT'L.: SEE NOTES SCALE: N/A REV.: A3 UNIT: mm PAGE: 1/1