

REV.	ECN NO.	CONTENT	DATE	ENGINEER
A0			2023 20/04	

SPECIFICATIONS:

- ELECTRICAL CHARACTERISTICS:
 - 1-1. RATING: 24V 3A
 - 1-2. CONTACT RESISTANCE: 50mΩ MAX.(INITIAL)
 - 1-3. DIELECTRIC WITHSTANDING VOLTAGE: 500V AC FOR ONE MINUTE
 - 1-4. INSULATION RESISTANCE: 100MΩ MIN. MEASURED BY 500V DC
- MECHANICAL CHARACTERISTICS:
 - 2-1. INSERTION FORCE : 0.3~3.0 KGF
 - 2-2. WITHDRAWAL FORCE : 0.3~3.0 KGF
- LIFE TEST: 5,000 CYCLES MIN.
- FOR REFLOW SOLDERING LEAD-FREE PROCESS.

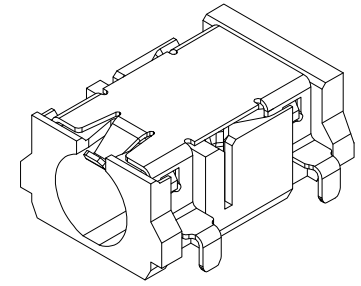

3D VIEW

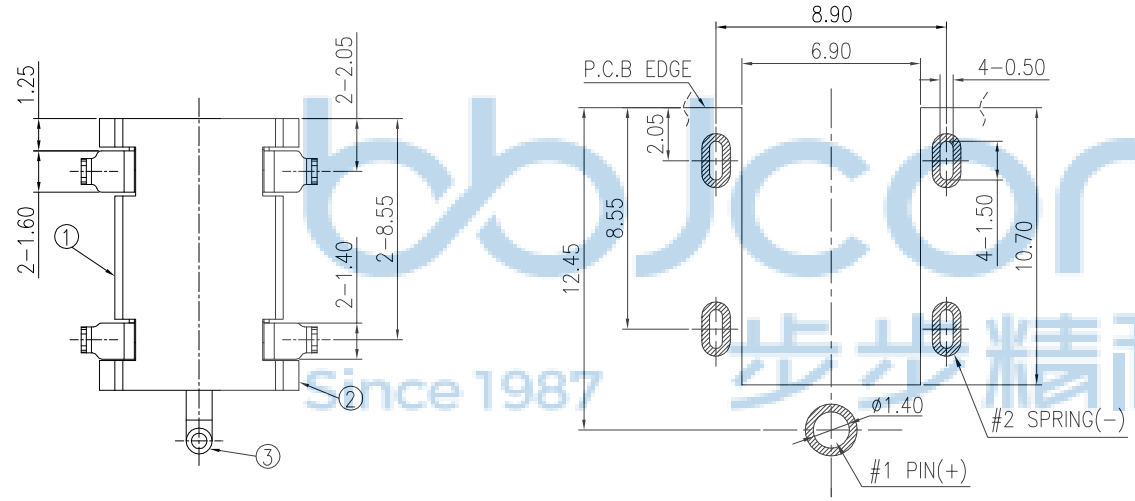
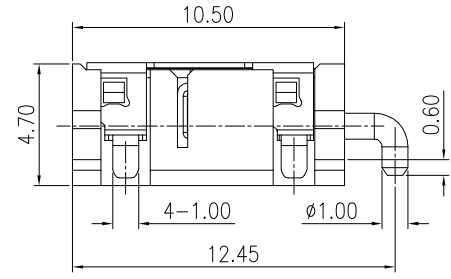
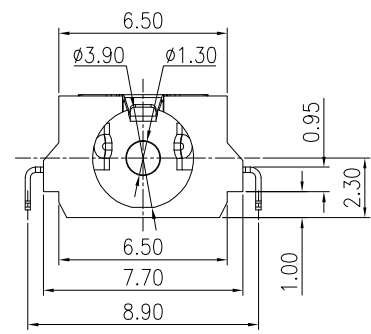

RECOMMENDED PCB LAYOUT
TOP VIEW (TOLERANCE:±0.05)



ELECTRICAL CIRCUIT

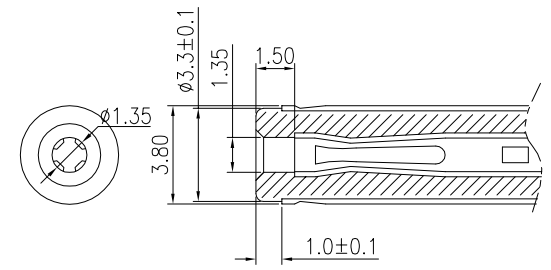

MATE PLUG

③	CENTER PIN	1	BRASS ϕ 1.3	Au
②	TERMINAL	1	PHOSPHOR BRONZE 0.2t	Au
①	HOUSING	1	HIGHT TEMPERATURE PLASTIC	Black
NO.	DESCRIPTION	QTY	MATERIAL	PLATING & COLOR

THIS DOCUMENT IS THE SOLE PROPERTY OF BBJconn Technology Co.,Ltd. Corporation AND SHOULD NOT BE USED IN WHOLE OR IN PART WITHOUT PRIOR WRITTEN PERMISSION.

PDWG.NO: 0076-1

DR. SGF 23/05'02

APPD. JM_Zheng 23/05'02

CHKD. LYX 23/05'02

NAME: DC座 1.30针 全铜 沉板1.0 四脚插 (DCJR0008-F02G1BR-A)

PJ. NO.: DC.03.42-12-B003

SIZE: A4 | DRW NO.:

FINISH: SEE NOTES | MAT'L.: SEE NOTES

SCALE: N/A | REV.: A3 | UNIT: mm | PAGE: 1/1

深圳市步步精科技有限公司

REV.	ECN NO.	CONTENT	DATE	ENGINEER
AO			2023 20/04	

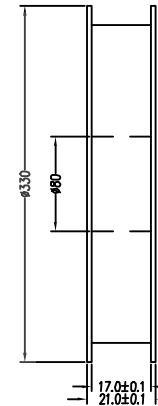
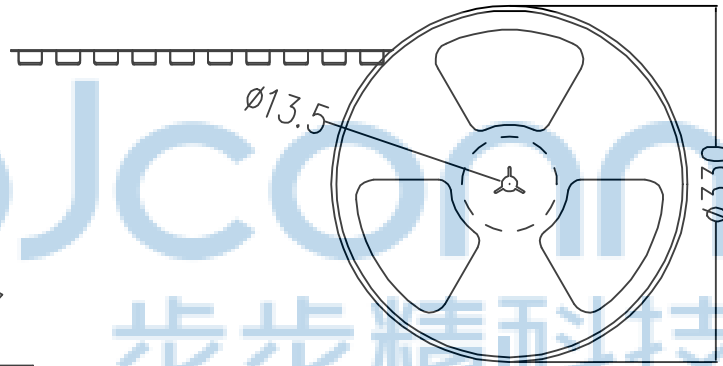
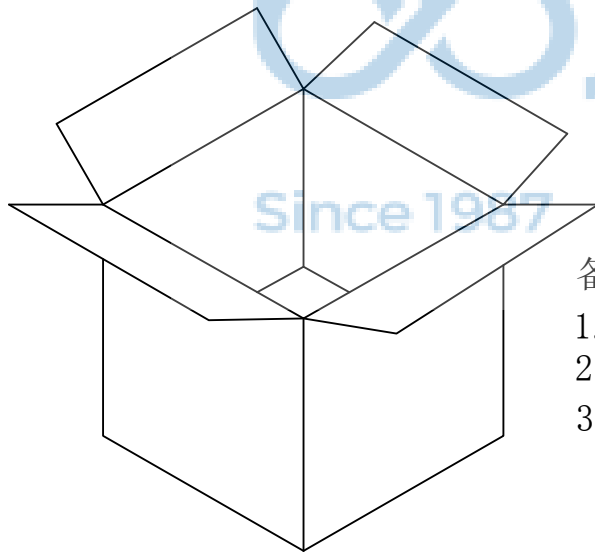
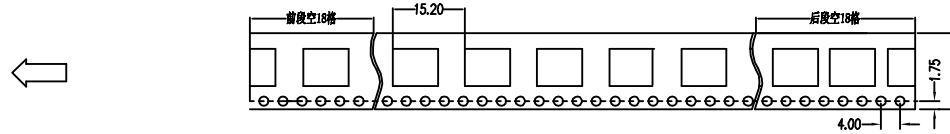
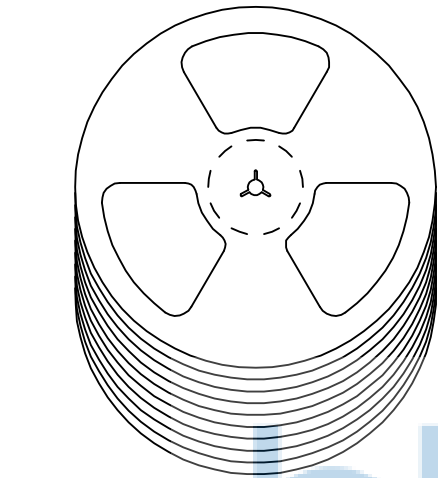

备注:

1. 包装数量: 1000/PCS/卷, 10卷/箱或15卷/箱。
2. 包装袋长度: 每卷前后各空10-20个空格, 中间包装。
3. 材质:
载体: 聚丙烯 (PS), 阻抗 $10^{6-9} \Omega$
上带: 聚乙烯 (PET), 阻抗 $10^{6-11} \Omega$
卷盘: 聚苯乙烯。

纸箱规格: 345*345*23MM

纸箱规格: 345*345*35MM

THIS DOCUMENT IS THE SOLE PROPERTY OF BBJconn Technology Co.,Ltd. Corporation AND SHOULD NOT BE USED IN WHOLE OR IN PART WITHOUT PRIOR WRITTEN PERMISSION.		深圳市步步精科技有限公司 .X: ±0.38 .X': ±3" .XX: ±0.25 .X": ±2" .XXX: ±0.13 .XX': ±1"		NAME: DC座 1.30针 全铜 沉板1.0 四脚插 (DCJR0008-F02G1BR-A)	
APPD.	JM_Zheng	23/05'02	PJ. NO.: DC.03.42-12-B003		SIZE: A4
CHKD.	LYX	23/05'02	FINISH: SEE NOTES		MAT'L.: SEE NOTES
PDWG.NO:	0076-1	DR.	SGF	23/05'02	SCALE: N/A
				REV.: A3	UNIT: mm
				PAGE: 1/1	