

REV.	ECN NO.	CONTENT	DATE	ENGINEER
AO			2023 20/04	

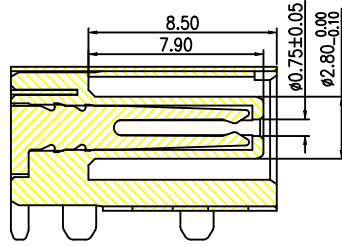

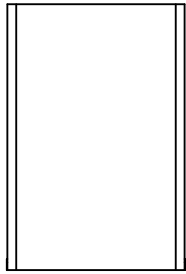

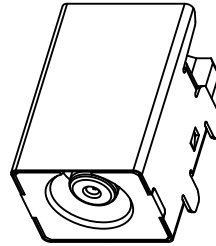

SECTION A-A

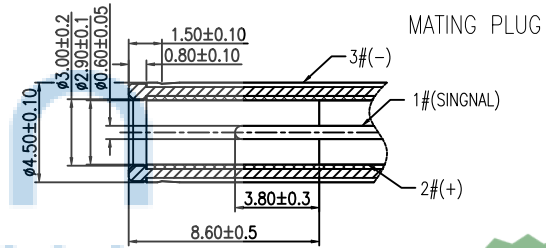
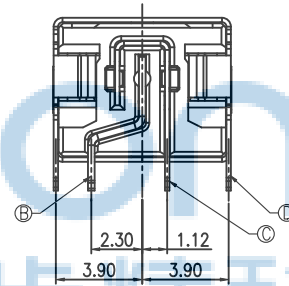
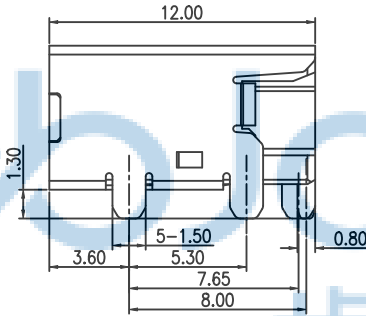
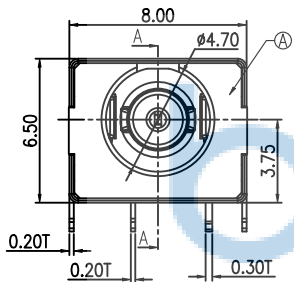

SPECIFICATION:

1. RATING: DC 20V 6.5A
2. CONTACT RESISTANCE: 30m $\Omega$  MAX.
3. INSULATION RESISTANCE: 100 M $\Omega$  MIN.
4. WITHSTAND VOLTAGE: 500 VAC
5. INSERTION FORCE: 30N MAX.
6. EXTRACTION FORCE: 6N MIN.
7. DURABILITY: 5,000 CYCLES



SCHEMATIC	
	2#(+)
	1#(SIGNAL)
	3#(-)

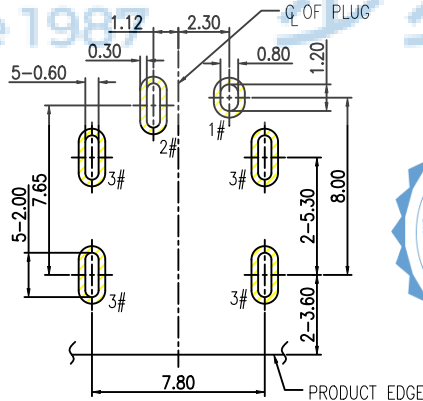
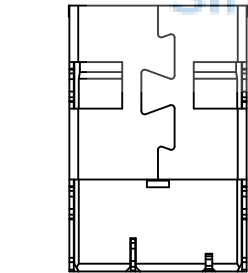

RECOMMENDED PCB LAYOUT  
TOP VIEW TOLERANCE:  $\pm 0.05$



NO.	DESCRIPTION	MATERIAL	REMARKS	QTY
D	SHELL	COPPER ALLOY	Ni 50 $\mu$ MIN.	1
C	SPRING	COPPER ALLOY	GOLD FLASH/MATTE TIN 80 $\mu$ /Ni 40 $\mu$	1
B	CENTER PIN	COPPER ALLOY	GOLD FLASH/MATTE TIN 80 $\mu$ /Ni 40 $\mu$	1
A	HOUSING	HIGH TEMP.THERMOPLASTIC	BLACK	1

THIS DOCUMENT IS THE SOLE PROPERTY OF BBJconn Technology Co.,Ltd. Corporation AND SHOULD NOT BE USED IN WHOLE OR IN PART WITHOUT PRIOR WRITTEN PERMISSION.		 <b>深圳市步步精科技有限公司</b>	
APPD.	JM_Zheng 23/05'02	NAME:	DC座 DC-0.6针 全铜 卧式 六脚插 (DC450060-0142-20000H)
CHKD.	LYX 23/05'02	SIZE:	A4 DRW NO.:
PDWG.NO:	0386-2	FINISH:	SEE NOTES
DR.	SGF 23/05'02	MAT'L:	SEE NOTES
		SCALE:	N/A
		REV.:	A3
		UNIT:	mm
		PAGE:	1/1

REV.	ECN NO	CONTENT	DATE	ENGINEER
AO			2023 20/04	

拉出方向

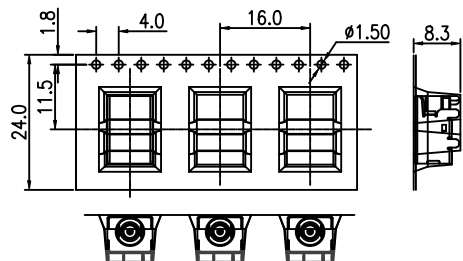

拉出方向

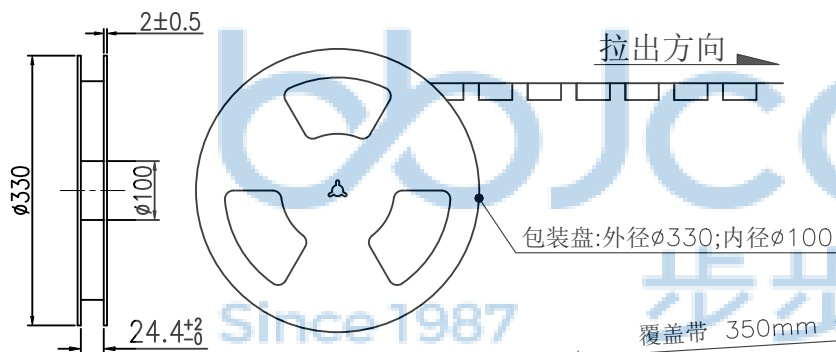

包装盘:外径 $\phi$ 330;内径 $\phi$ 100

覆盖带 350mm 最少.

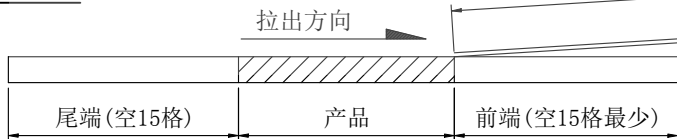

包装盘标签

总共10层

PE袋:

外箱,1PCS

透明胶带

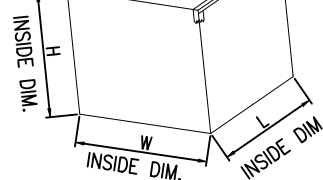

备注:

- 材料规格:
  - 载带:T=0.50mm,黑色
  - 包装盘:蓝色
  - 纸箱: L=335,W=335,H=300
- 包装数量:
 

500PCS/卷, 10卷(5000PCS)/箱
- 上盖带拔离力: 0.1N~0.7N(10~70gf);  
拔离角度: 165°~180°;  
拔离速度: 300mm/分钟.



THIS DOCUMENT IS THE  
SOLE PROPERTY OF  
BBJconn Technology Co.,Ltd.  
Corporation AND SHOULD  
NOT BE USED IN WHOLE  
OR IN PART WITHOUT  
PRIOR WRITTEN PERMISSION.  
PDWG.NO: 0386-2



深圳市步步精科技有限公司

.X:  $\pm 0.38$  X':  $\pm 3'$   
.XX:  $\pm 0.25$  .X'':  $\pm 2'$   
.XXX:  $\pm 0.13$  .XX':  $\pm 1'$

NAME:  
DC座 DC-0.6针 全铜 卧式 六脚插 (DC450060-0142-2000H)

APPD. JM\_Zheng 23/05'02

PJ. NO.: DC.02\_K2-12-G001

CHKD. LYX 23/05'02

SIZE: A4 DRW NO.:

DR. SGF 23/05'02

FINISH: SEE NOTES MAT'L.: SEE NOTES

SCALE: N/A REV.: A3 UNIT: mm PAGE: 1/1