

REV.	ECN NO.	CONTENT	DATE	ENGINEER
AO			2023 20/04	

SPECIFICATION:

1. RATING: DC 20V 6.5A
2. CONTACT RESISTANCE: 30m Ω MAX.
3. INSULATION RESISTANCE: 100 M Ω MIN.
4. WITHSTAND VOLTAGE: 500 VAC
5. INSERTION FORCE: 30N MAX.
6. EXTRACTION FORCE: 6N MIN.
7. DURABILITY: 5,000 CYCLES

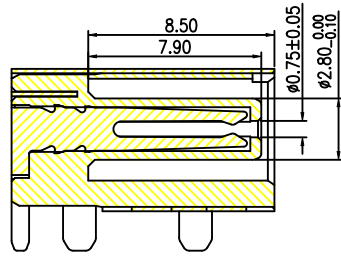

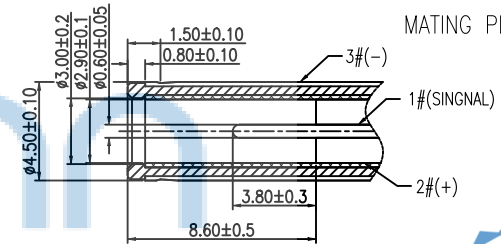
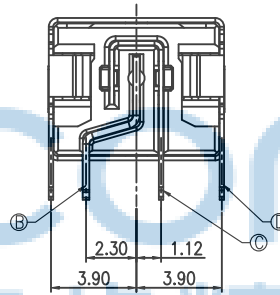
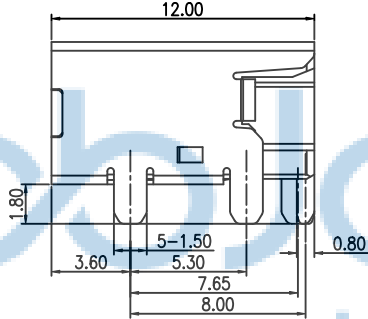
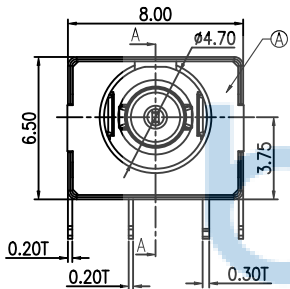
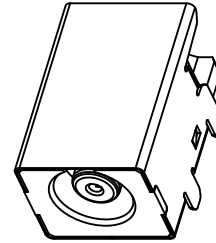
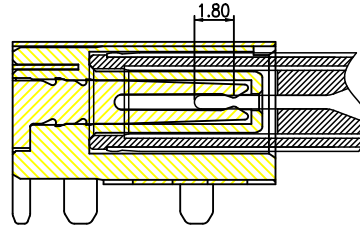

SECTION A-A



MATING PLUG



SCHEMATIC	
	2#(+)
	1#(SIGNAL)
	3#(-)

D	SHELL	C5210	Ni 50u"MIN.	1
C	SPRING	C5210	GOLD FLASH/MATTE TIN 80u"/Ni 40u"	1
B	CENTER PIN	C5210	GOLD FLASH/MATTE TIN 80u"/Ni 40u"	1
A	HOUSING	PA10T	BLACK	1
no.	DESCRIPTION	MATERIAL	REMARKS	QTY

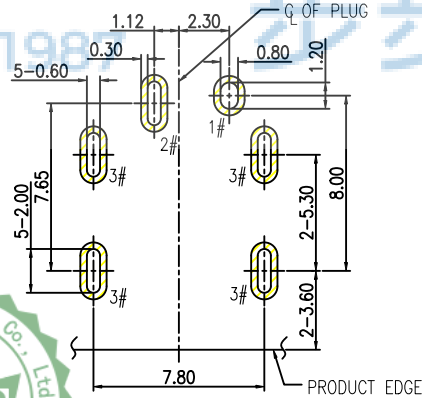

RECOMMENDED PCB LAYOUT
TOP VIEW TOLERANCE: ±0.05

THIS DOCUMENT IS THE SOLE PROPERTY OF BBJconn Technology Co., Ltd. Corporation AND SHOULD NOT BE USED IN WHOLE OR IN PART WITHOUT PRIOR WRITTEN PERMISSION. PDWG.NO: 0386-2		 深圳市步步精科技有限公司	
.X: ±0.38 .XX: ±0.25 .XXX: ±0.13		X': ±3" X'': ±2" X'X': ±1"	
APPD. JM_Zheng 23/05'02		NAME: DC座 DC-0.6针 全铜 卧式 六脚插 (DC450060-0355-20000H)	
CHKD. LYX 23/05'02		P.J. NO.: DC.02.K2-12-G002	
DR. SGF 23/05'02		SIZE: A4 DRW NO.:	
		FINISH: SEE NOTES MAT'L: SEE NOTES	
		SCALE: N/A REV.: A3 UNIT: mm PAGE: 1/1	

拉出方向

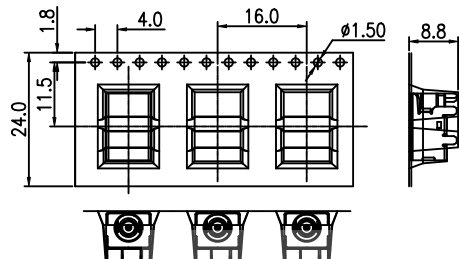

拉出方向

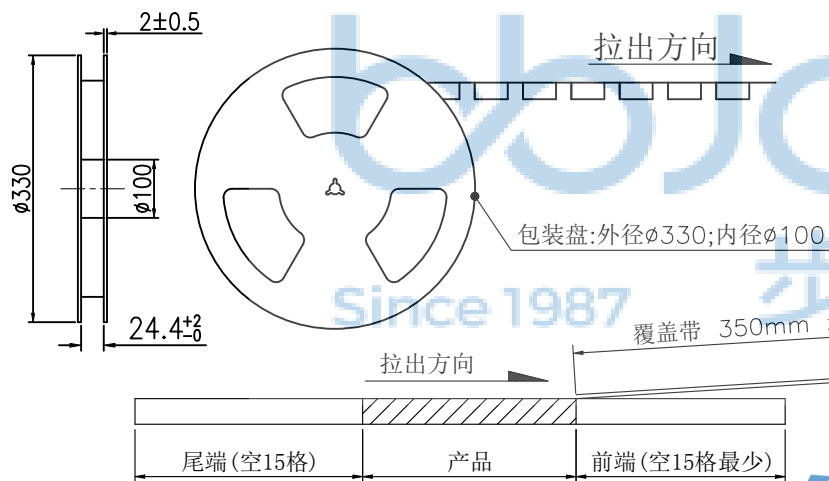

总共10层

PE袋:

外箱, 1PCS

透明胶带

INSIDE DIM. H
INSIDE DIM. W
INSIDE DIM. L

备注:

- 材料规格:
 - 载带: T=0.50mm, 黑色
 - 包装盘: 蓝色
 - 纸箱: L=335, W=335, H=300
- 包装数量: 400PCS/卷, 10卷(4000PCS)/箱
- 上盖带拔离力: 0.1N~0.7N(10~70gf); 拔离角度: 165°~180°; 拔离速度: 300mm/分钟。



THIS DOCUMENT IS THE SOLE PROPERTY OF BBJconn Technology Co., Ltd. Corporation AND SHOULD NOT BE USED IN WHOLE OR IN PART WITHOUT PRIOR WRITTEN PERMISSION.		深圳市步步精科技有限公司 .X: ± 0.38 .X': ± 3 .XX: ± 0.25 .X'': ± 2 .XXX: ± 0.13 .X''': ± 1	
APPD.	JM_Zheng 23/05'02	NAME:	DC座 DC-0.6针 全铜 卧式 六脚插 (DC150060-0355-20000H)
CHKD.	LYX 23/05'02	PJ. NO.:	DC.02.K2-12-G002
PDWG.NO:	0386-2	SIZE:	A4 DRW NO.:
DR.	SGF 23/05'02	FINISH:	SEE NOTES
		MAT'L.:	SEE NOTES
		SCALE:	N/A
		REV.:	A3
		UNIT:	mm
		PAGE:	1/1