

REV.	ECN NO	CONTENT	DATE	ENGINEER
AO			2023 20/04	

SPECIFICATION:
 1. RATING: DC 30V 25A
 2. CONTACT RESISTANCE:
 CENTER PIN: 30m Ω MAX(INITIAL).
 40m Ω MAX(FINAL).
 DC_IN+/DC_IN-: 15m Ω MAX(INITIAL).
 25m Ω MAX(FINAL).
 3. INSULATION RESISTANCE: 100 M Ω MIN.
 4. WITHSTAND VOLTAGE: 500 VAC
 5. INSERTION FORCE: 25N MAX.
 6. EXTRACTION FORCE: 6N MIN.
 7. DURABILITY: 5,000 CYCLES

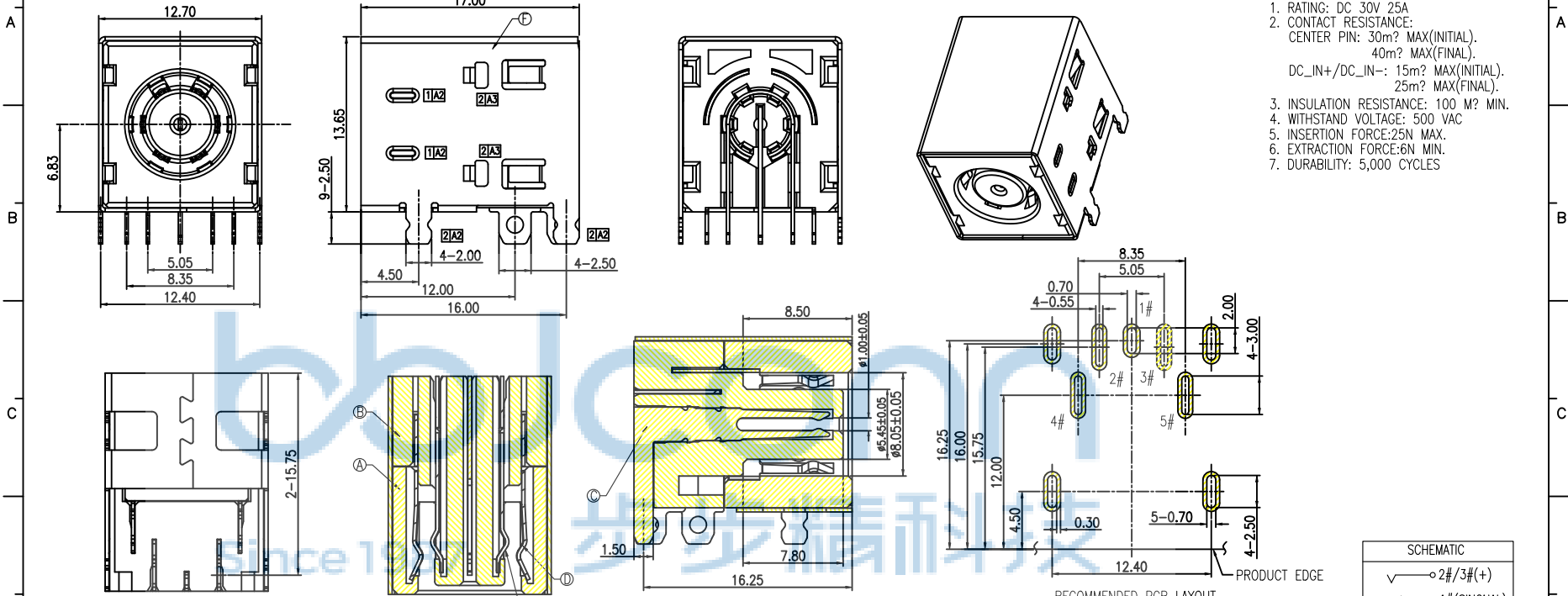

RECOMMENDED PCB LAYOUT
 TOP VIEW TOLERANCE: ±0.05

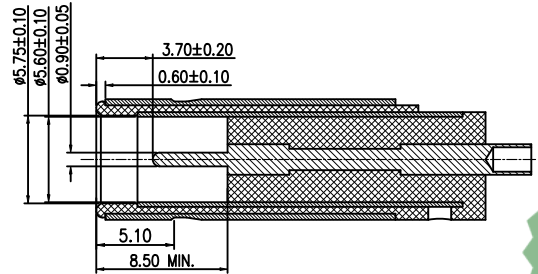
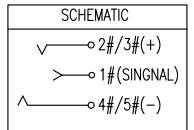

F	SHELL	SUS 304	Ni 50 μ MIN.	1
E	ANODE	C7025	Ni 40 μ ⁺	1
D	NEGATIVE	C7025	Ni 40 μ ⁺	1
C	CENTER PIN	C5210	Au1 μ (CONTACT AREA)/Sn80 μ /Ni 40 μ ⁺	1
B	COVER	PA10T	BLACK	1
A	HOUSING	PA10T	BLACK	1
NO.	DESCRIPTION	MATERIAL	REMARKS	QTY

THIS DOCUMENT IS THE SOLE PROPERTY OF BBJconn Technology Co., Ltd. Corporation AND SHOULD NOT BE USED IN WHOLE OR IN PART WITHOUT PRIOR WRITTEN PERMISSION.

PDWG.No: 0386-2

DR. SGF 23/05/02

APPD. JM_Zheng 23/05/02

CHKD. LYX 23/05/02

NAME: DC DC-0.9针 全铜 卧式 九脚插 (DC790090-0289-20000H-A5)

PJ. NO.: DC.02.K2-12-G003

SIZE: A4 DRW NO.:

FINISH: SEE NOTES MAT'L: SEE NOTES

SCALE: N/A REV.: A3 UNIT: mm PAGE: 1/1

深圳市步步精科技有限公司

拉出方向

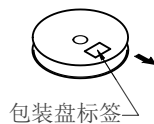
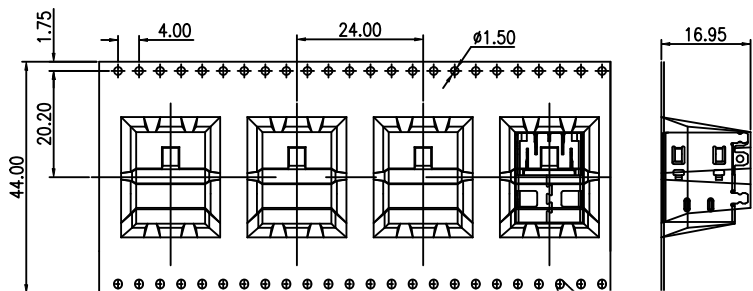

拉出方向

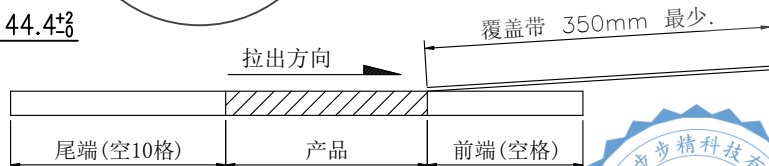
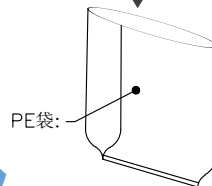
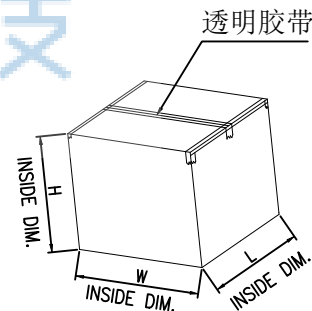
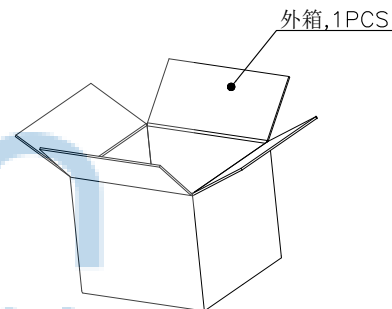
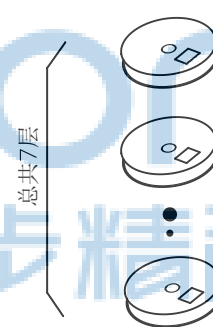
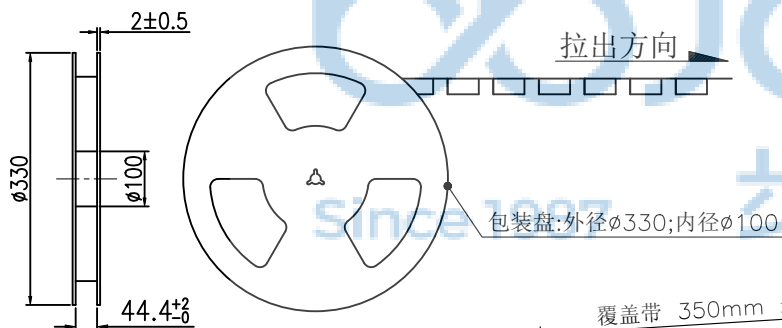

备注:

- 材料规格:
 - 载带: T=0.50mm, 黑色
 - 包装盘: 蓝色
 - 纸箱: L=335, W=335, H=380
- 包装数量: 150PCS/卷, 7卷(1050PCS)/箱
- 上盖带拔离力: 0.1N~0.7N(10~70gf);
拔离角度: 165°~180°;
拔离速度: 300mm/分钟.



THIS DOCUMENT IS THE
SOLE PROPERTY OF
BBJconn Technology Co., Ltd.
Corporation AND SHOULD
NOT BE USED IN WHOLE
OR IN PART WITHOUT
PRIOR WRITTEN PERMISSION.
PDWG.NO: 0386-2



深圳市步步精科技有限公司

.X: ±0.38 .XX: ±0.25 .XXX: ±0.13	X': ±3" .X': ±2" .XX': ±1"	NAME: DC# DC-0.91# 全铜 卧式 九脚插 (DC790090-0289-20000H-A5)
APPD. JM_Zheng 23/05/02	CHKD. LYX 23/05/02	PJ. NO.: DC.02.K2-12-G003
DR. SGF 23/05/02	SCALE: N/A	SIZE: A4
	REV.: A3	DRW NO.:
	UNIT: mm	FINISH: SEE NOTES
	PAGE: 1/1	MAT'L: SEE NOTES