

REV.	ECN NO.	CONTENT	DATE	ENGINEER
A0			2023 20/04	

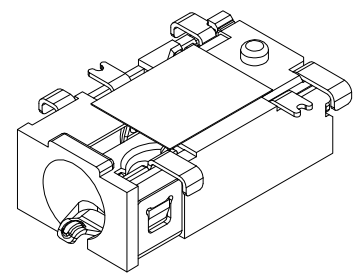

3D VIEW

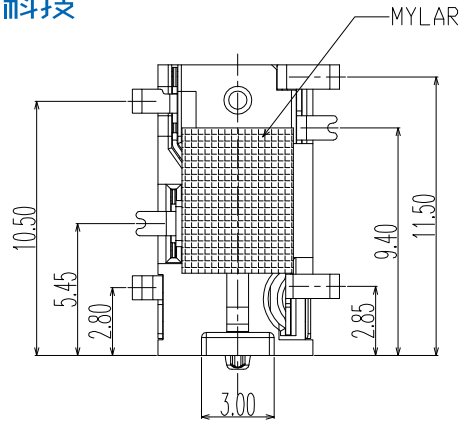
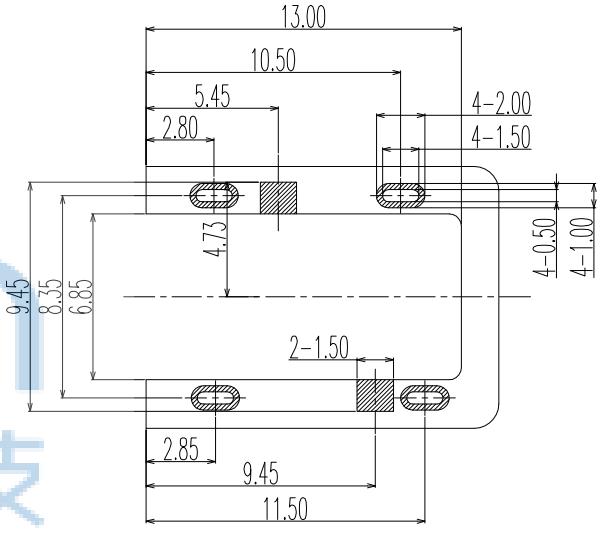
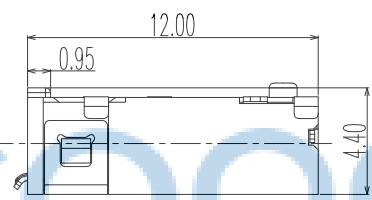
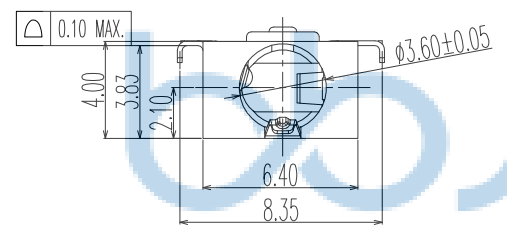

P.C.B LAYOUT
TOP VIEW

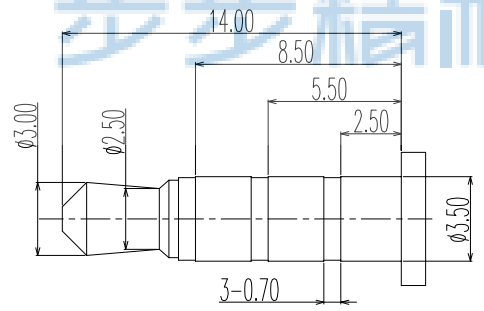
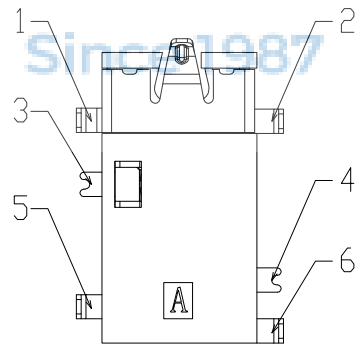

($\phi 3.50$ mm 4 POLE PLUG DETAIL DRAWING)

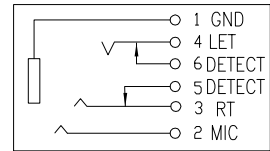
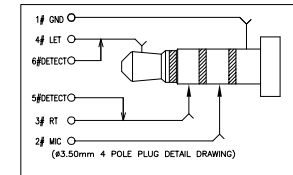

SCHEMATIC



7	TERMINAL 6#	1	BRASS; NICKEL UNDER PLATING OVERALL; GOLD PLATING ON SOLDER AREA ;GOLD PLATING ON CONTACT AREA	
6	TERMINAL 5#	1	BRASS; NICKEL UNDER PLATING OVERALL; GOLD PLATING ON SOLDER AREA ;GOLD PLATING ON CONTACT AREA	
5	TERMINAL 4#	1	PHOSPHOR BRONZE; NICKEL UNDER PLATING OVERALL; GOLD PLATING ON SOLDER AREA ;GOLD PLATING ON CONTACT AREA	
4	TERMINAL 3#	1	PHOSPHOR BRONZE; NICKEL UNDER PLATING OVERALL; GOLD PLATING ON SOLDER AREA ;GOLD PLATING ON CONTACT AREA	
3	TERMINAL 2#	1	PHOSPHOR BRONZE; NICKEL UNDER PLATING OVERALL; GOLD PLATING ON SOLDER AREA ;GOLD PLATING ON CONTACT AREA	
2	TERMINAL 1#	1	PHOSPHOR BRONZE; THE BOTTOM OF THE NICKEL; THE WHOLE GOLD PLATING.	
1	HOUSING	1	HIGHT TEMPERATURE PLASTIC COLOR BLACK	
ITEM	NAME	QTY	DESCRIPTION	NOTE

THIS DOCUMENT IS THE SOLE PROPERTY OF BBJconn Technology Co.,Ltd. Corporation AND SHOULD NOT BE USED IN WHOLE OR IN PART WITHOUT PRIOR WRITTEN PERMISSION.
PDWG.NO: 0076-1

深圳市步步精科技有限公司

NAME: 3.5耳机座 无头 板上型 四脚插两脚贴 四节 (PJ35A067-F06G1BR-B)

PJ. NO.: PJ.04.22-01-3013

SIZE: A4 DRW NO.:

FINISH: SEE NOTES MAT'L.: SEE NOTES

SCALE: N/A REV.: A0 UNIT: mm PAGE: 1/1

APPD. JM_Zheng 23/05/02
CHKD. LYX 23/05/02
DR. SGF 23/05/02

REV.	ECN NO.	CONTENT	DATE	ENGINEER
A0			2023 20/04	

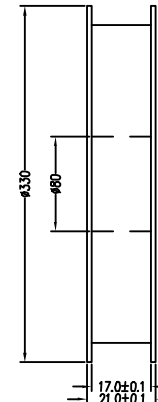
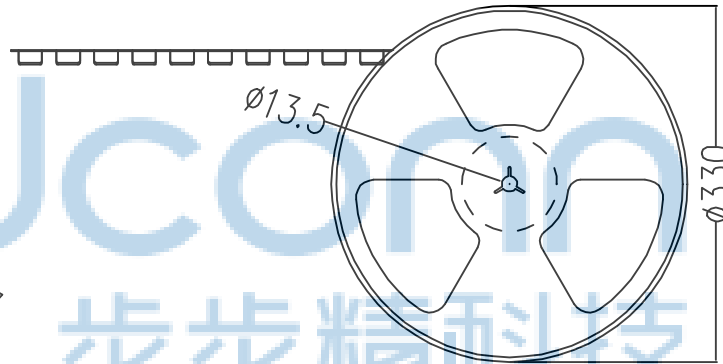
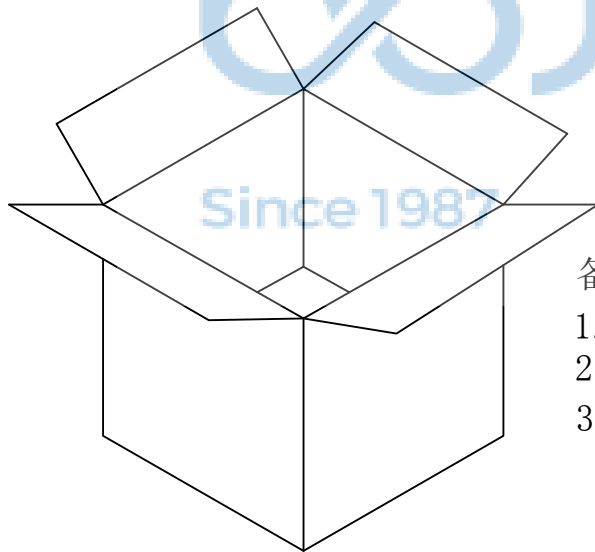
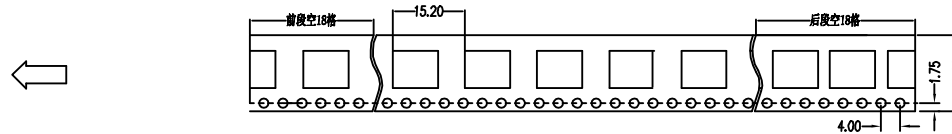
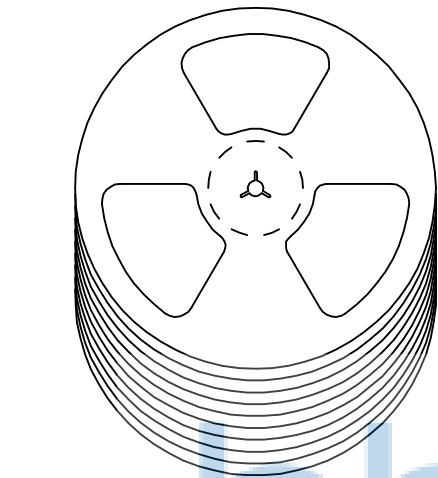

备注:

1. 包装数量: 1000/PCS/卷, 10卷/箱或15卷/箱。
2. 包装袋长度: 每卷前后各空10-20个空格, 中间包装。
3. 材质:
载体: 聚丙烯 (PS), 阻抗 $10^{6-9} \Omega$
上带: 聚乙烯 (PET), 阻抗 $10^{6-11} \Omega$
卷盘: 聚苯乙烯。

纸箱规格: 345*345*23MM

纸箱规格: 345*345*35MM

THIS DOCUMENT IS THE SOLE PROPERTY OF BBJconn Technology Co.,Ltd. Corporation AND SHOULD NOT BE USED IN WHOLE OR IN PART WITHOUT PRIOR WRITTEN PERMISSION.		PDWG.NO: 0076-1		深圳市步步精科技有限公司 .X: ±0.38 .X': ±3" .XX: ±0.25 .X": ±2" .XXX: ±0.13 .XX': ±1"		NAME: 3.5耳机座 无头 板上型 四脚插两脚贴 四节 (PJ35A067-F06G1BR-B) PJ. NO.: PJ.04.22-01-3013 SIZE: A4 DRW NO.: FINISH: SEE NOTES MAT'L.: SEE NOTES SCALE: N/A REV.: A0 UNIT: mm PAGE: 1/1		
APPD.	JM_Zheng	23/05'02	CHKD.	LYX	23/05'02	DR.	SGF	23/05'02