

REV.	ECN NO	CONTENT	DATE	ENGINEER
A0			2023 20/04	

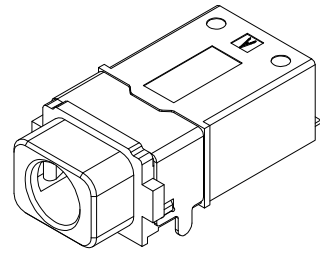

3D VIEW

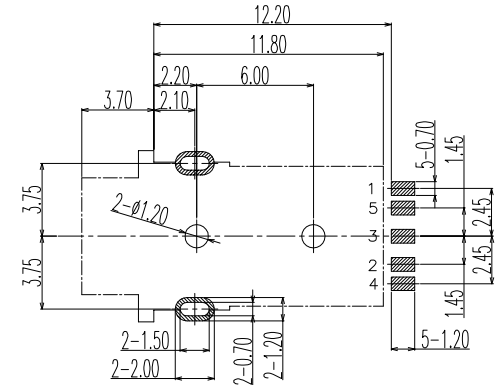
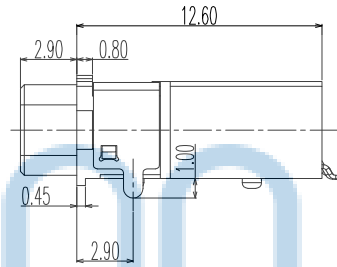
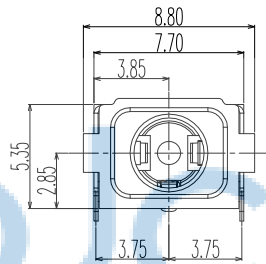
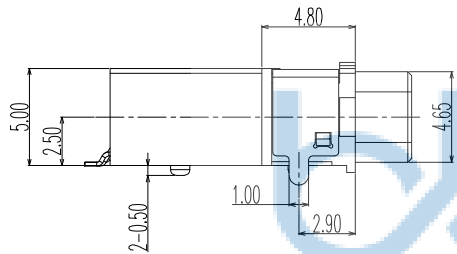
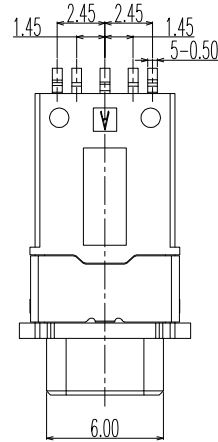

RECOMMENDED P.C.B LAYOUT
TOP VIEW

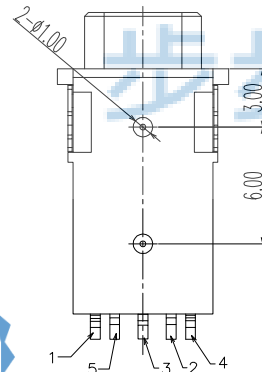

SCHEMATIC (PLUG OUT)

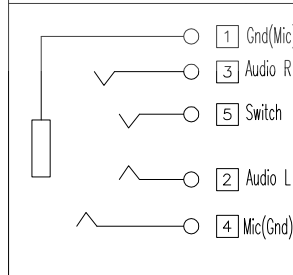

SCHEMATIC (PLUG IN)

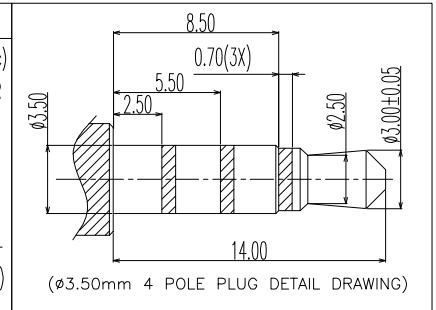
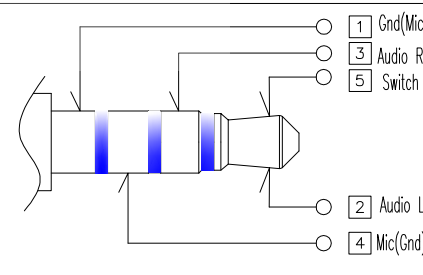

ITEM	NAME	QTY	DESCRIPTION	NOTE
8	COVER	1	HIGH TEMPERATURE PLASTIC COLOR BLACK	
7	HOUSING	1	HIGH TEMPERATURE PLASTIC COLOR BLACK	
6	SHELL	1	PHOSPHOR BRONZE; NICKEL PLATED OVERALL	
5	TERMINAL 5#	1		
4	TERMINAL 4#	1	PHOSPHOR BRONZE; GOLD FLASH ON CONTACT AREA; GOLD FLASH PLATING ON SOLDER TAIL AREA, ALL OVER NICKEL PLATED	
3	TERMINAL 3#	1		
2	TERMINAL 2#	1	PHOSPHOR BRONZE; GOLD FLASH ON CONTACT AREA; GOLD FLASH PLATING ON SOLDER TAIL AREA, ALL OVER NICKEL PLATED	
1	TERMINAL 1#	1		

THIS DOCUMENT IS THE
SOLE PROPERTY OF
BBJconn Technology Co.,Ltd.
Corporation AND SHOULD
NOT BE USED IN WHOLE
OR IN PART WITHOUT
PRIOR WRITTEN PERMISSION.

深圳市步步精科技有限公司

.X: ±0.38 X*: ±3*
.XX: ±0.25 X*: ±2*
.XXX: ±0.13 .XX*: ±1*

NAME:
3.5耳机座 方头 板上型 带挂 两脚插五脚贴 四节 防水IPX7 (PJ35A099-F06J1BR-A)

APPD. JM_Zheng 23/05'02

PJ. NO.: PJ.04.22-01-3015

CHKD. LYX 23/05'02

SIZE: A4 DRW NO.:

PDWG.NO: 0076-1

FINISH: SEE NOTES MAT'L.: SEE NOTES

DR. SGF 23/05'02

SCALE: N/A REV.: A0 UNIT: mm PAGE: 1/1

REV.	ECN NO.	CONTENT	DATE	ENGINEER
A0			2023 20/04	

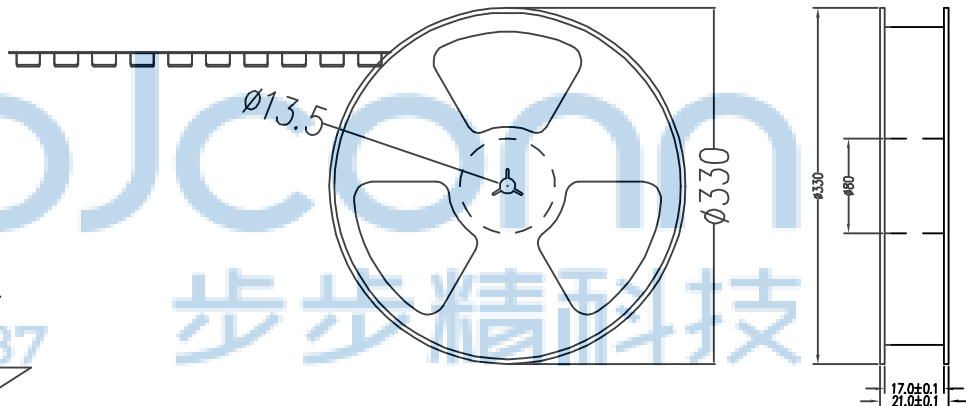
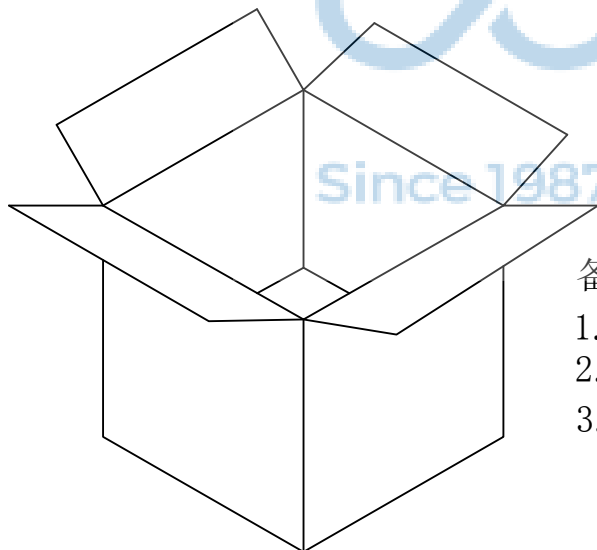
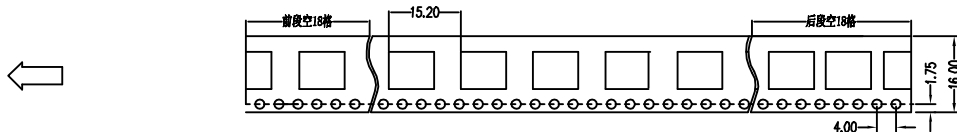
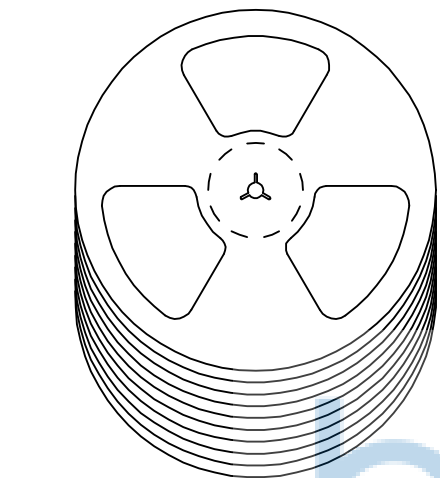

备注:

1. 包装数量: 1000/PCS/卷, 10卷/箱或15卷/箱。
2. 包装袋长度: 每卷前后各空10-20个空格, 中间包装。
3. 材质:
载体: 聚丙烯 (PS), 阻抗 $10^{6-9} \Omega$
上带: 聚乙烯 (PET), 阻抗 $10^{6-11} \Omega$
卷盘: 聚苯乙烯。

纸箱规格: 345*345*23MM

纸箱规格: 345*345*35MM

THIS DOCUMENT IS THE SOLE PROPERTY OF BBJconn Technology Co.,Ltd. Corporation AND SHOULD NOT BE USED IN WHOLE OR IN PART WITHOUT PRIOR WRITTEN PERMISSION.		深圳市步步精科技有限公司	
.X: ±0.38 .XX: ±0.25 .XXX: ±0.13		NAME: 3.5耳机座 方头 板上型 带柱 两脚插五脚贴 四节 防水IPX7 (PJ35A099-F06J1BR-A)	
APPD. JM_Zheng 23/05'02		PJ. NO.: PJ.04.22-01-3015	
CHKD. LYX 23/05'02		SIZE: A4 DRW NO.:	
PDWG.NO: 0076-1		FINISH: SEE NOTES MAT'L.: SEE NOTES	
DR. SGF 23/05'02		SCALE: N/A REV.: A0 UNIT: mm PAGE: 1/1	