

REV.	ECN NO	CONTENT	DATE	ENGINEER
A0			2023 20/04	

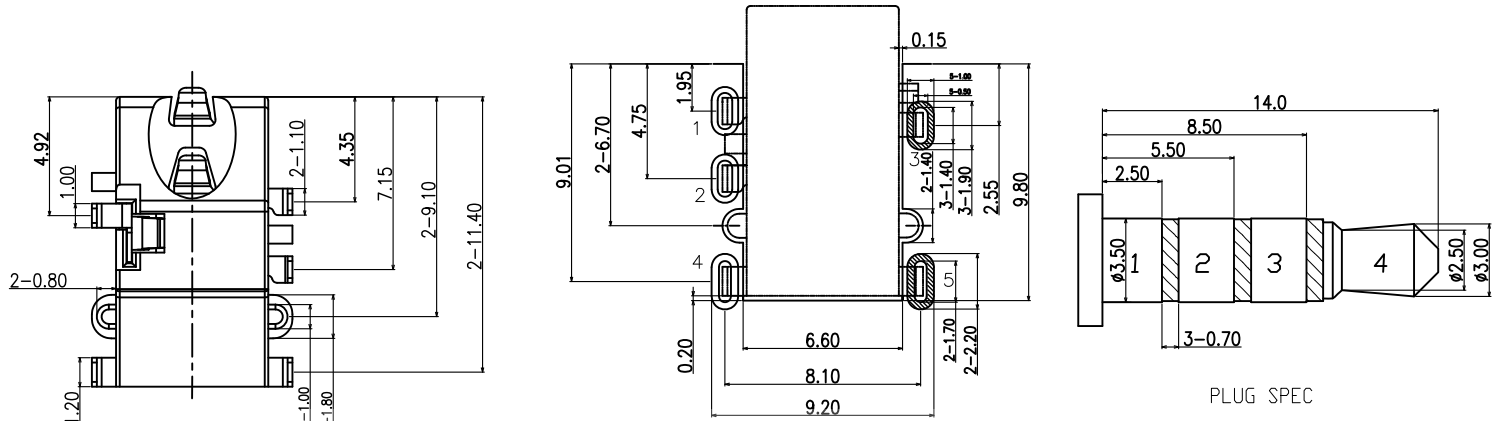

- NOTES:
- CONTACT CURRENT RATING: 1A.
  - CONTACT RESISTANCE: 50 mΩ MAX.;
  - INSULATION RESISTANCE: 1000Ω MIN.;
  - DIELECTRIC WITHSTANDING: 500V AC MIN.;
  - DURABILITY: 5,000 CYCLES MIN.;
  - CONNECTOR MATING FORCES: 29.4N (3.00Kgf) MAX.;
  - CONNECTOR UNMATING FORCES: 2.94N(0.30Kgf) MIN.;

RECOMMENDED P.C.B LAYOUT  
(TOP VIEW) TOLERANCE: ±0.05

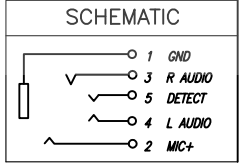
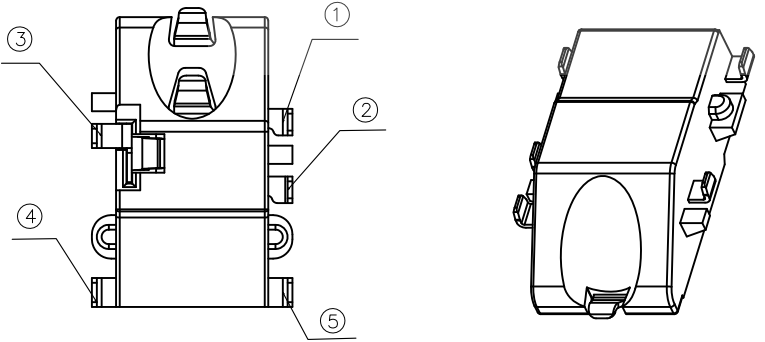
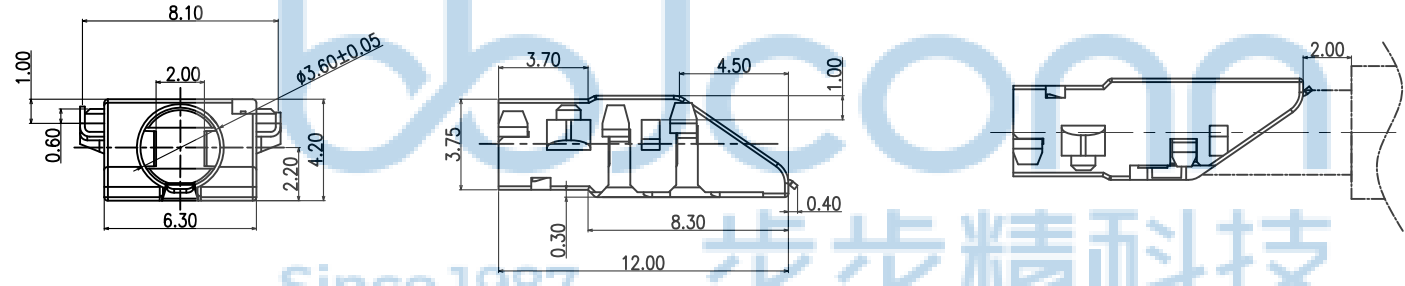

⑥	HOUSING	1	HIGHT TEMPERATURE PLASTIC		Black
⑤	CONTACT D	1	PHOSPHOR BRONZE 0.20T	Au-Plated	
④	CONTACT C	1	PHOSPHOR BRONZE 0.20T	Au-Plated	
③	CONTACT B	1	PHOSPHOR BRONZE 0.20T	Au-Plated	
②	CONTACT B	1	PHOSPHOR BRONZE 0.20T	Au-Plated	
①	CONTACT A	1	PHOSPHOR BRONZE 0.20T	Au-Plated	
ITFM	PART NAMF	Q'TY	MATFR TAL	DFSCRIPTION	RFMARK

THIS DOCUMENT IS THE SOLE PROPERTY OF BBJconn Technology Co., Ltd. Corporation AND SHOULD NOT BE USED IN WHOLE OR IN PART WITHOUT PRIOR WRITTEN PERMISSION.		深圳市步步精科技有限公司 .X: ±0.38    .X': ±3" .XX: ±0.25    .X'': ±2" .XXX: ±0.13    .X''': ±1"		NAME: 3.5耳机座 斜口 沉板1.0 五脚插 四节 (PJ35B010-F05A1BR-A)	
APPD.	JM_Zheng	23/05'02	PJ. NO.: PJ.03.22-01-3005 SIZE: A4   DRW NO.:		
CHKD.	LYX	23/05'02	FINISH: SEE NOTES    MAT'L.: SEE NOTES		
PDWG.NO:	0076-1	DR.	SGF	23/05'02	SCALE: N/A    REV.: A0    UNIT: mm    PAGE: 1/1

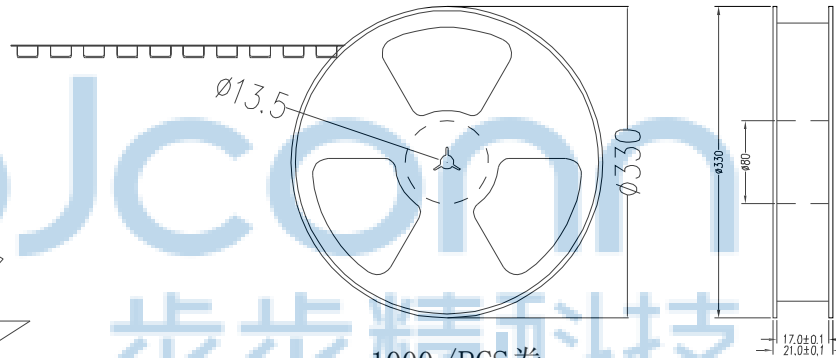
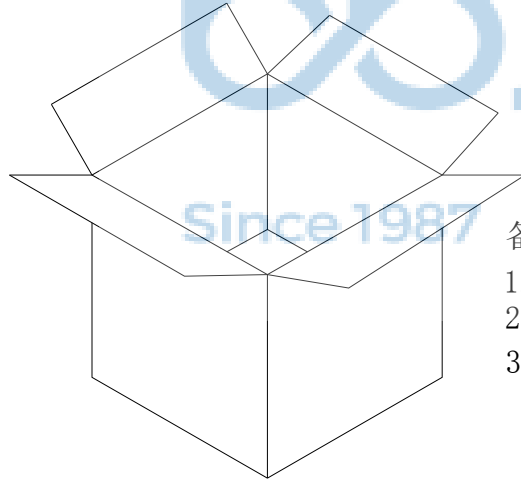
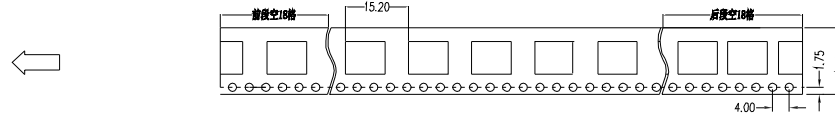
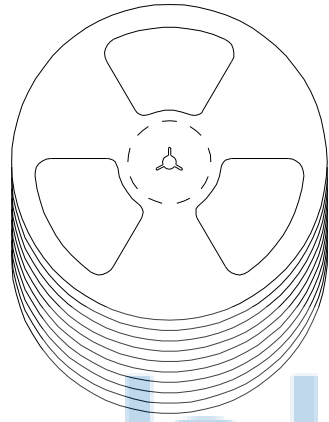

备注:

1. 包装数量: 1000 /PCS /卷, 10卷 /箱或15卷 /箱。
2. 包装袋长度: 每卷前后各空10-20个空格, 中间包装。
3. 材质:  
载体: 聚丙烯 (PS), 阻抗 $10^{6-9} \Omega$   
上带: 聚乙烯 (PET), 阻抗 $10^{6-11} \Omega$   
卷盘: 聚苯乙烯。

纸箱规格: 345\*345\*23MM  
纸箱规格: 345\*345\*35MM



THIS DOCUMENT IS THE SOLE PROPERTY OF BBJconn Technology Co.,Ltd. Corporation AND SHOULD NOT BE USED IN WHOLE OR IN PART WITHOUT PRIOR WRITTEN PERMISSION.		深圳市步步精科技有限公司	
.X: ±0.38 .XX: ±0.25 .XXX: ±0.13		X': ±3" X'': ±2" X'': ±1"	
APPD.	JM_Zheng	23/05'02	NAME: 3.5耳机座 斜口 沉板1.0 五脚插 四节 (PJ35B010-F05A1BR-A)
CHKD.	LYX	23/05'02	PJ. NO.: PJ.03.22-01-3005
DR.	SGF	23/05'02	SIZE: A4   DRW NO.:
PDWG.NO: 0076-1		FINISH: SEE NOTES   MAT'L.: SEE NOTES	
		SCALE: N/A   REV.: AO   UNIT: mm   PAGE: 1/1	