

REV.	ECN NO.	CONTENT	DATE	ENGINEER
AO			2023 20/04	

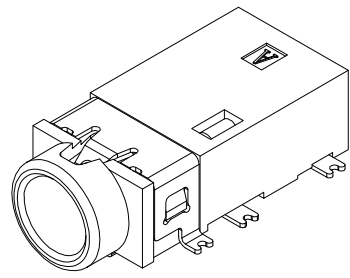

3D VIEW

- CONTACT CURRENT RATING: 1A.
- CONTACT RESISTANCE: 50 mΩ MAX.;
- INSULATION RESISTANCE: 100MΩ MIN.;
- DIELECTRIC WITHSTANDING: 500V AC MIN.;
- DURABILITY: 5,000 CYCLES MIN.;
- CONNECTOR MATING FORCES: 29.4N MAX.;
- CONNECTOR UNMATING FORCES: 2.94N MIN.;

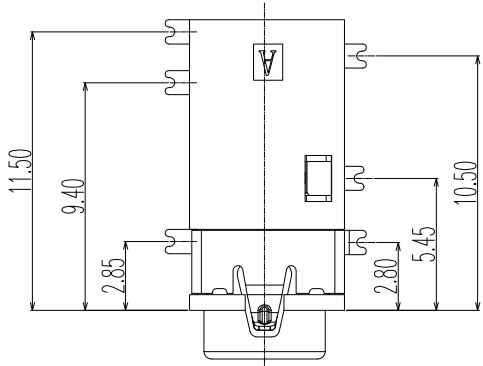
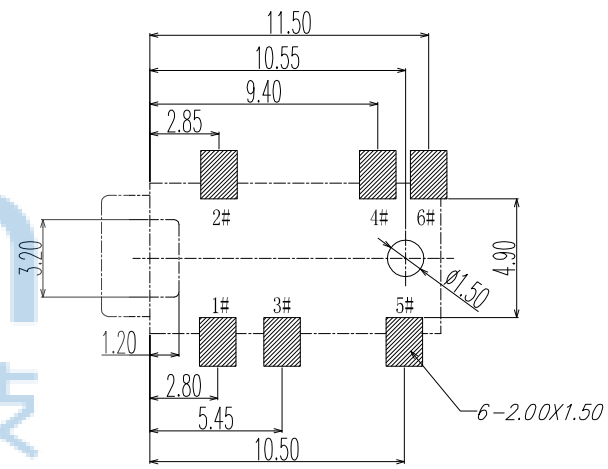
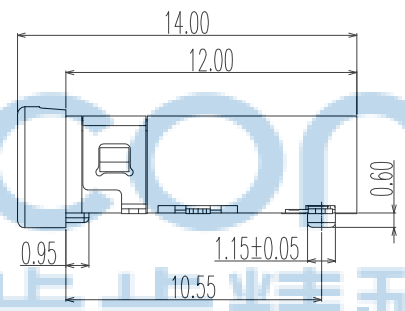
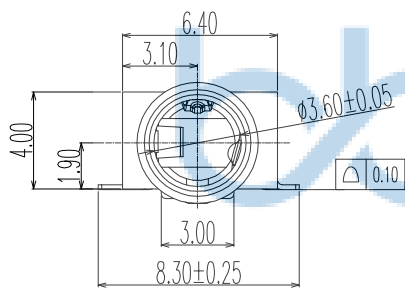

P.C.B LAYOUT
TOP VIEW

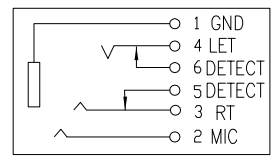
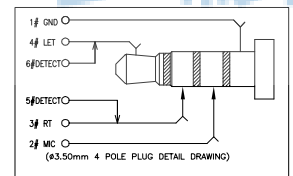
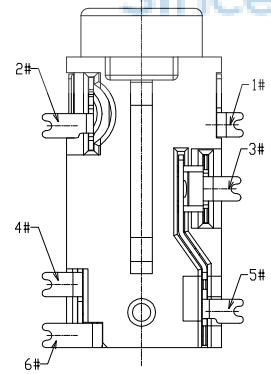

SCHEMATIC

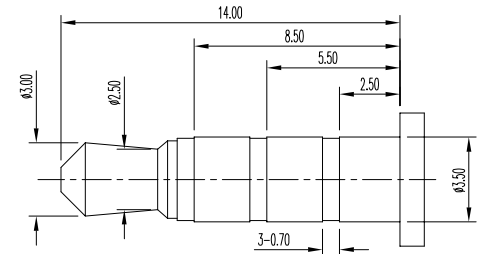

(ø3.50mm 4 POLE PLUG DETAIL DRAWING)



ITEM	NAME	QTY	DESCRIPTION	NOTE
7	TERMINAL 6#	1	BRASS; NICKEL UNDER PLATING OVERALL;GOLD PLATING ON SOLDER AREA ;GOLD PLATING ON CONTACT AREA	
6	TERMINAL 5#	1	BRASS; NICKEL UNDER PLATING OVERALL;GOLD PLATING ON SOLDER AREA ;GOLD PLATING ON CONTACT AREA	
5	TERMINAL 4#	1	PHOSPHOR BRONZE; NICKEL UNDER PLATING OVERALL;GOLD PLATING ON SOLDER AREA ;GOLD PLATING ON CONTACT AREA	
4	TERMINAL 3#	1	PHOSPHOR BRONZE; NICKEL UNDER PLATING OVERALL;GOLD PLATING ON SOLDER AREA ;GOLD PLATING ON CONTACT AREA	
3	TERMINAL 2#	1	PHOSPHOR BRONZE; NICKEL UNDER PLATING OVERALL;GOLD PLATING ON SOLDER AREA ;GOLD PLATING ON CONTACT AREA	
2	TERMINAL 1#	1	PHOSPHOR BRONZE; THE BOTTOM OF THE NICKEL; THE WHOLE GOLD PLATING.	
1	HOUSING	1	HIGHT TEMPERATURE PLASTIC COLOR BLACK	

THIS DOCUMENT IS THE SOLE PROPERTY OF BBJconn Technology Co.,Ltd. Corporation AND SHOULD NOT BE USED IN WHOLE OR IN PART WITHOUT PRIOR WRITTEN PERMISSION.

PDWG.NO: 0076-1

DR. SGF 23/05'02

深圳市步步精科技有限公司

NAME: 3.5耳机座 有头 六脚贴 带柱 四节 (PJ35A057-F06G1ER-A)

PJ. NO.: PJ.01.22-01-3022

SIZE: A4 DRW NO.:

FINISH: SEE NOTES MAT'L.: SEE NOTES

SCALE: N/A REV.: A0 UNIT: mm PAGE: 1/1

REV.	ECN NO.	CONTENT	DATE	ENGINEER
AO			2023 20/04	

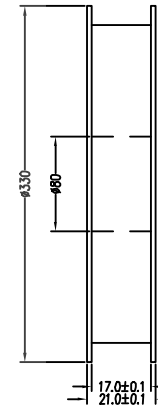
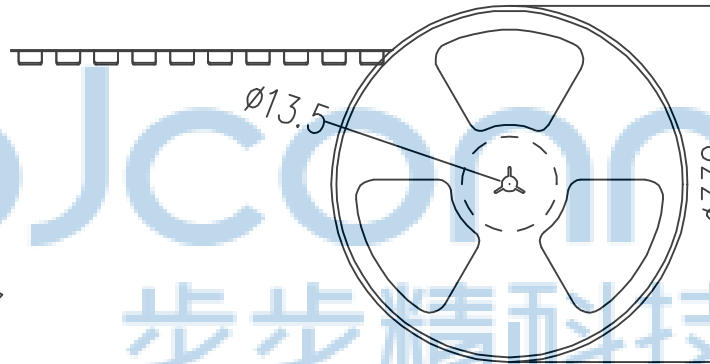
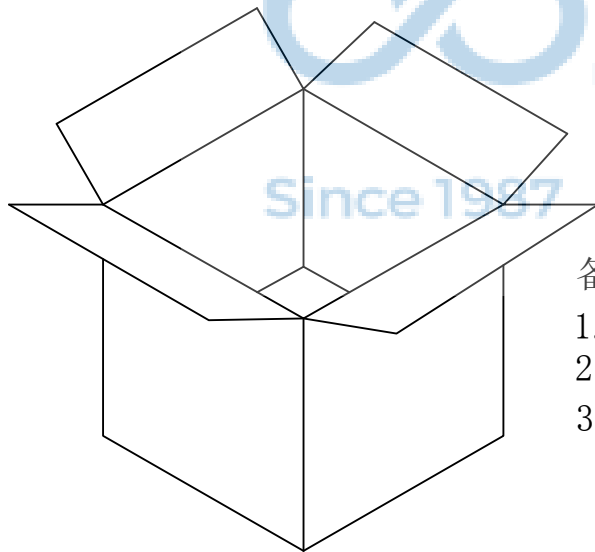
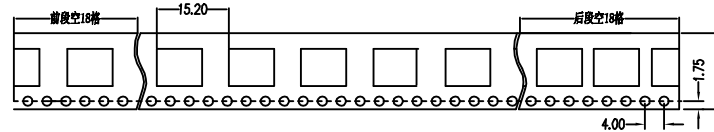
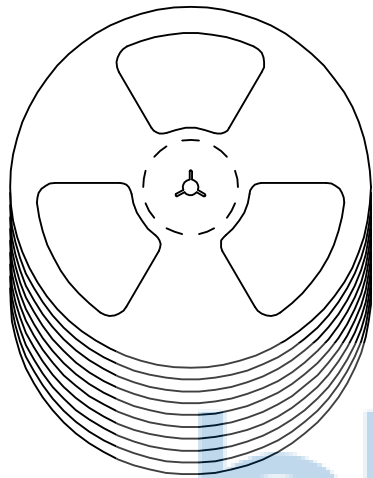

备注:

1. 包装数量: 1000/PCS/卷, 10卷/箱或15卷/箱。
2. 包装袋长度: 每卷前后各空10-20个空格, 中间包装。
3. 材质:
载体: 聚丙烯 (PS), 阻抗 $10^{6-9} \Omega$
上带: 聚乙烯 (PET), 阻抗 $10^{6-11} \Omega$
卷盘: 聚苯乙烯。

纸箱规格: 345*345*23MM

纸箱规格: 345*345*35MM

THIS DOCUMENT IS THE SOLE PROPERTY OF BBJconn Technology Co.,Ltd. Corporation AND SHOULD NOT BE USED IN WHOLE OR IN PART WITHOUT PRIOR WRITTEN PERMISSION.		深圳市步步精科技有限公司	
.X: ±0.38 .XX: ±0.25 .XXX: ±0.13		X': ±3" X'': ±2" X'X': ±1"	
APPD.	JM_Zheng	23/05'02	NAME: 3.5耳机座 有头 六脚贴 带柱 四节 (PJ35A057-F06G1ER-A)
CHKD.	LYX	23/05'02	PJ. NO.: PJ.01.22-01-3022
DR.	SGF	23/05'02	SIZE: A4 DRW NO.:
PDWG.NO: 0076-1		FINISH: SEE NOTES MAT'L.: SEE NOTES	
		SCALE: N/A REV.: A0 UNIT: mm PAGE: 1/1	