

|      |         |         |               |          |
|------|---------|---------|---------------|----------|
| REV. | ECN NO. | CONTENT | DATE          | ENGINEER |
| AO   |         |         | 2023<br>20/04 |          |

- CONTACT CURRENT RATING: 1A.
- CONTACT RESISTANCE: 50 mΩ MAX.;
- INSULATION RESISTANCE: 100MΩ MIN.;
- DIELECTRIC WITHSTANDING: 500V AC MIN.;
- DURABILITY: 5,000 CYCLES MIN.;
- CONNECTOR MATING FORCES: 29.4N MAX.;
- CONNECTOR UNMATING FORCES: 2.94N MIN.;

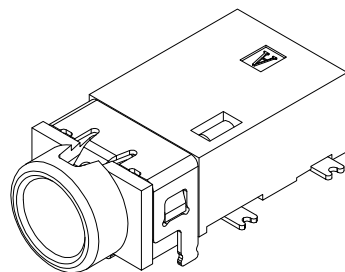

3D VIEW

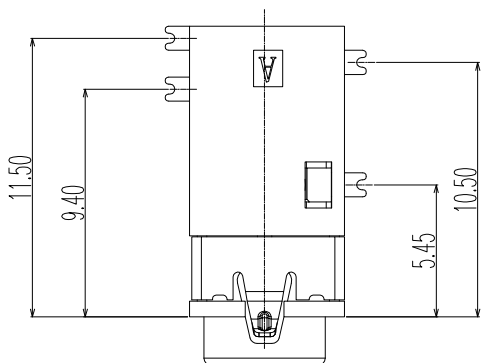
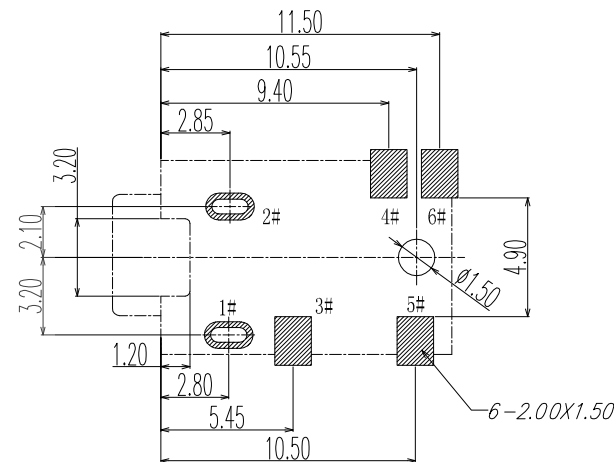
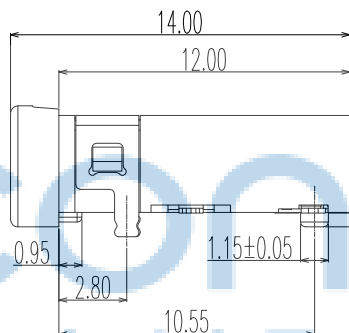
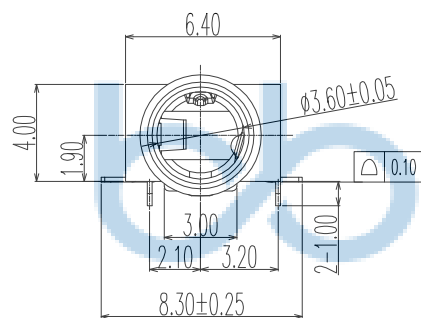

P.C.B LAYOUT  
TOP VIEW

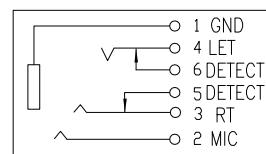
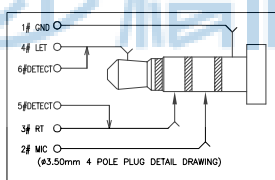
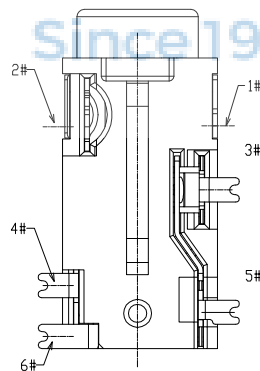

SCHEMATIC

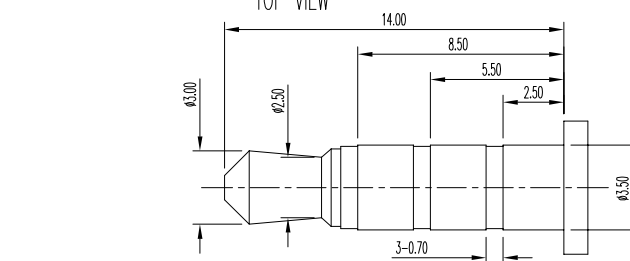

(φ3.50mm 4 POLE PLUG DETAIL DRAWING)



| ITEM | NAME        | QTY | DESCRIPTION  | NOTE |
|------|-------------|-----|--|------|
| 7    | TERMINAL 6# | 1   | BRASS; NICKEL UNDER PLATING OVERALL; GOLD PLATING ON SOLDER AREA ;GOLD PLATING ON CONTACT AREA           |      |
| 6    | TERMINAL 5# | 1   | BRASS; NICKEL UNDER PLATING OVERALL; GOLD PLATING ON SOLDER AREA ;GOLD PLATING ON CONTACT AREA           |      |
| 5    | TERMINAL 4# | 1   | PHOSPHOR BRONZE; NICKEL UNDER PLATING OVERALL; GOLD PLATING ON SOLDER AREA ;GOLD PLATING ON CONTACT AREA |      |
| 4    | TERMINAL 3# | 1   | PHOSPHOR BRONZE; NICKEL UNDER PLATING OVERALL; GOLD PLATING ON SOLDER AREA ;GOLD PLATING ON CONTACT AREA |      |
| 3    | TERMINAL 2# | 1   | PHOSPHOR BRONZE; NICKEL UNDER PLATING OVERALL; GOLD PLATING ON SOLDER AREA ;GOLD PLATING ON CONTACT AREA |      |
| 2    | TERMINAL 1# | 1   | PHOSPHOR BRONZE; THE BOTTOM OF THE NICKEL; THE WHOLE GOLD PLATING.                                       |      |
| 1    | HOUSING     | 1   | HIGHT TEMPERATURE PLASTIC COLOR BLACK  |      |

THIS DOCUMENT IS THE SOLE PROPERTY OF BBJconn Technology Co., Ltd. Corporation AND SHOULD NOT BE USED IN WHOLE OR IN PART WITHOUT PRIOR WRITTEN PERMISSION.  
PDWG.NO: 0076-1

**深圳市步步精科技有限公司**

NAME: 3.5耳机座 有头 两脚插四脚贴 带柱 四节 (PJ35A057-F06G1ER-C)

APPD. JM\_Zheng 23/05/02

CHKD. LYX 23/05/02

DR. SGF 23/05/02

PJ. NO.: PJ.04.22-01-3012

SIZE: A4 DRW NO.:

FINISH: SEE NOTES MAT'L.: SEE NOTES

SCALE: N/A REV.: A0 UNIT: mm PAGE: 1/1

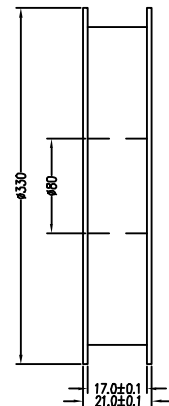
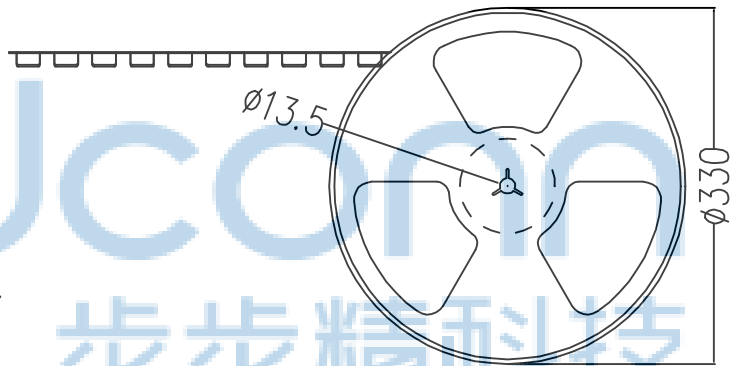
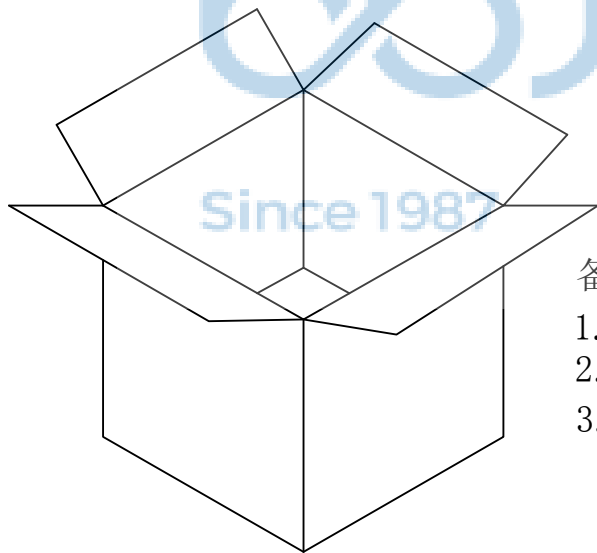
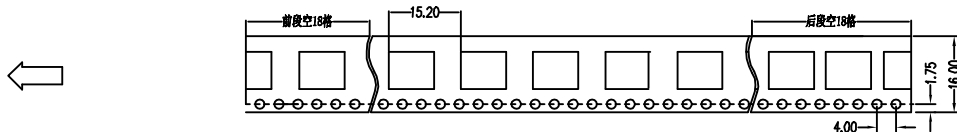
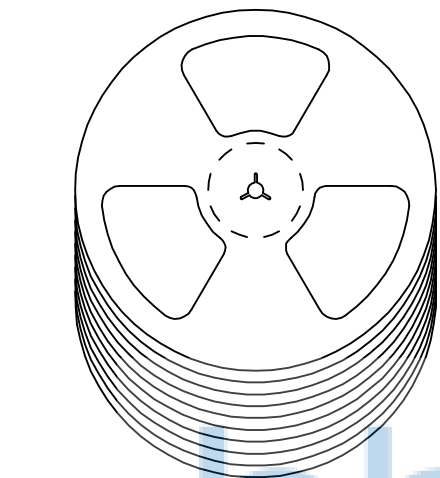

备注:

1. 包装数量: 1000/PCS/卷, 10卷/箱或15卷/箱。
2. 包装袋长度: 每卷前后各空10-20个空格, 中间包装。
3. 材质:  
载体: 聚丙烯 (PS), 阻抗 $10^{6-9} \Omega$   
上带: 聚乙烯 (PET), 阻抗 $10^{6-11} \Omega$   
卷盘: 聚苯乙烯。

纸箱规格: 345\*345\*23MM  
纸箱规格: 345\*345\*35MM

|  |          |                 |  |  |  |  |  |
|--|----------|-----------------|--|--|--|--|--|
| THIS DOCUMENT IS THE SOLE PROPERTY OF BBJconn Technology Co.,Ltd. Corporation AND SHOULD NOT BE USED IN WHOLE OR IN PART WITHOUT PRIOR WRITTEN PERMISSION. |          | PDWG.NO: 0076-1 |  | 深圳市步步精科技有限公司<br>.X: ±0.38 .X': ±3" .XX: ±0.25 .X": ±2" .XXX: ±0.13 .XX': ±1" |  | NAME: 3.5耳机座 有头 两脚插四脚贴 带柱 四节 (PJ35A057-F06G1ER-C)<br>PJ. NO.: PJ.04.22-01-3012<br>SIZE: A4 DRW NO.:<br>FINISH: SEE NOTES MAT'L.: SEE NOTES<br>SCALE: N/A REV.: A0 UNIT: mm PAGE: 1/1 |  |
| APPD.  | JM_Zheng | 23/05'02        |  |  |  |  |  |
| CHKD.  | LYX      | 23/05'02        |  |  |  |  |  |
| DR.  | SGF      | 23/05'02        |  |  |  |  |  |