

REV.	ECN NO.	CONTENT	DATE	ENGINEER
A0			2023 20/04	

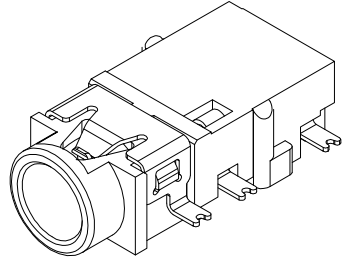

3D VIEW

- NOTES:
- CONTACT CURRENT RATING: 1A.
 - CONTACT RESISTANCE: 50 mΩ MAX.;
 - INSULATION RESISTANCE: 100MΩ MIN.;
 - DIELECTRIC WITHSTANDING: 500V AC MIN.;
 - DURABILITY: 5,000 CYCLES MIN.;
 - CONNECTOR MATING FORCES: 30N MAX.;
 - CONNECTOR UNMATING FORCES: 3N MIN.;

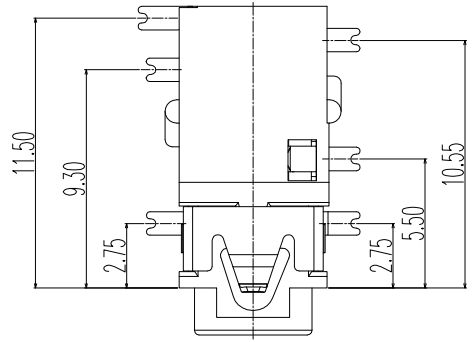
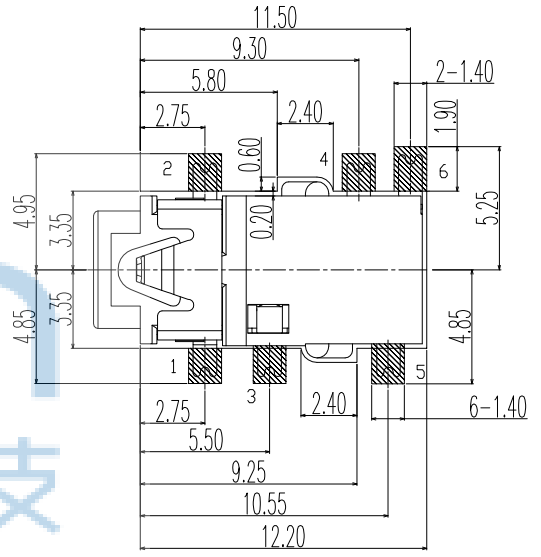
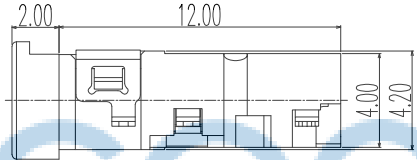
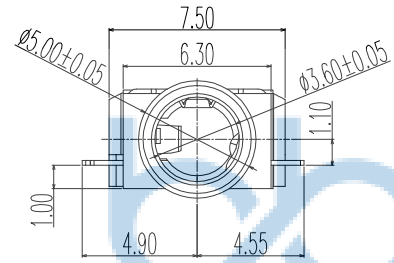

P.C.B LAYOUT
TOP VIEW

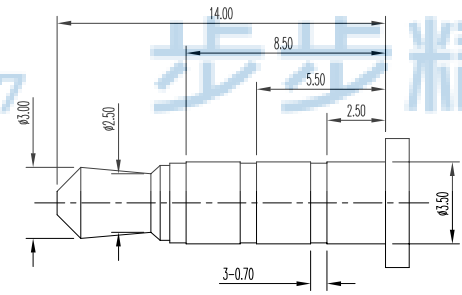
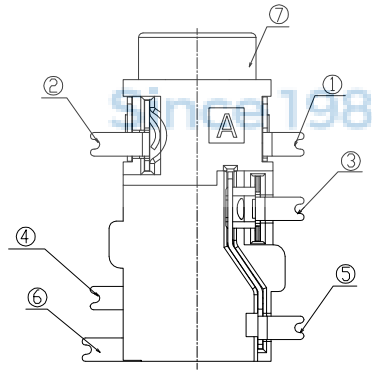

(ø3.50mm 4 POLE PLUG DETAIL DRAWING)

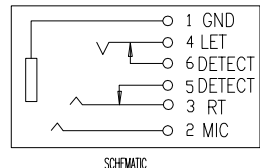
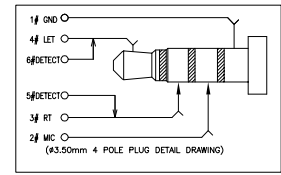

SCHEMATIC



ITEM	PART NAME	Q'TY	MATERIAL	REMARK
⑦	HOUSING	1	HIGHT TEMPERATURE PLASTIC COLOR BLACK	
⑥	CONTACT 6#	1	STAINLESS STEEL; NICKEL UNDER PLATING OVERALL,GOLD FLASH PLATING ON SOLDER AREA	T=0.2
⑤	CONTACT 5#	1	STAINLESS STEEL; NICKEL UNDER PLATING OVERALL,GOLD FLASH PLATING ON SOLDER AREA	T=0.2
④	CONTACT 4#	1	STAINLESS STEEL; NICKEL UNDER PLATING OVERALL,GOLD FLASH PLATING ON SOLDER AREA ;GOLD FLASH PLATING ON CONTACT AREA	T=0.2
③	CONTACT 3#	1	STAINLESS STEEL; NICKEL UNDER PLATING OVERALL,GOLD FLASH PLATING ON SOLDER AREA ;GOLD FLASH PLATING ON CONTACT AREA	T=0.2
②	CONTACT 2#	1	PHOSPHOR BRONZE; NICKEL UNDER PLATING OVERALL,GOLD FLASH PLATING ON SOLDER AREA ;GOLD FLASH PLATING ON CONTACT AREA	T=0.2
①	CONTACT 1#	1	STAINLESS STEEL; NICKEL UNDER PLATING OVERALL,GOLD FLASH ON OVERALL	T=0.2

THIS DOCUMENT IS THE SOLE PROPERTY OF **BBJconn Technology Co., Ltd.**

深圳市步步精科技有限公司

NAME: 3.5耳机座 有头 沉板1.0 六脚贴 四节 (PJ35A043-F06G1BR-E)

APPD. JM_Zheng 23/05'02

CHKD. LYX 23/05'02

DR. SGF 23/05'02

PJ. NO.: PJ.03.22-01-3021

SIZE: A4 DRW NO.:

FINISH: SEE NOTES MAT'L.: SEE NOTES

SCALE: N/A REV.: A0 UNIT: mm PAGE: 1/1

PDWG.NO: 0076-1

REV.	ECN NO.	CONTENT	DATE	ENGINEER
A0			2023 20/04	

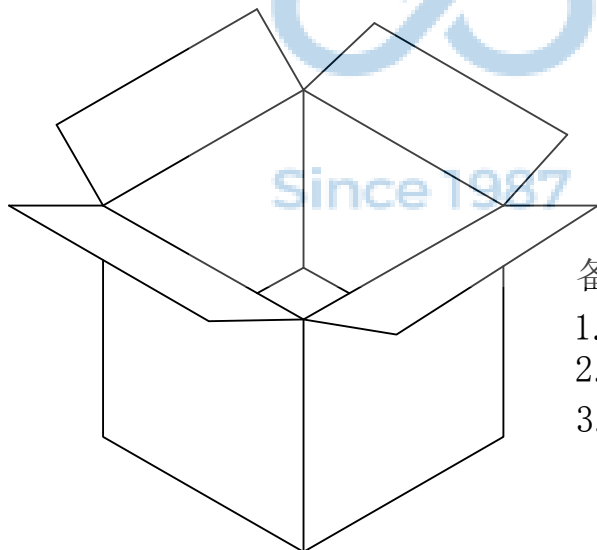
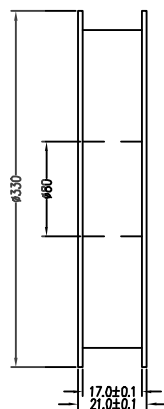
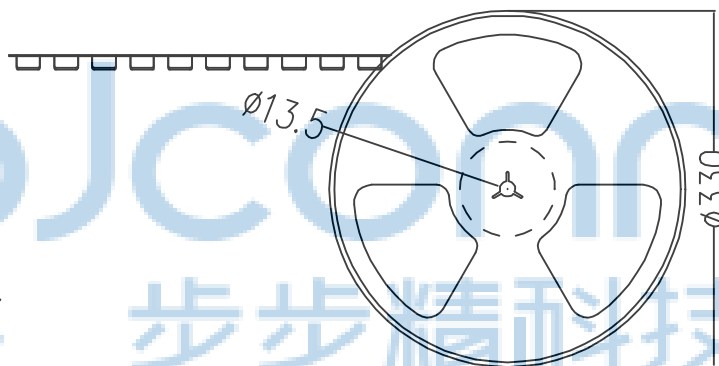
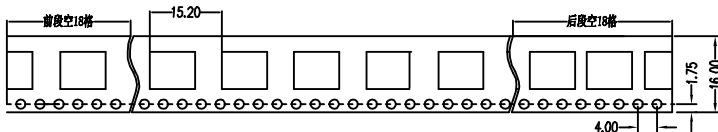
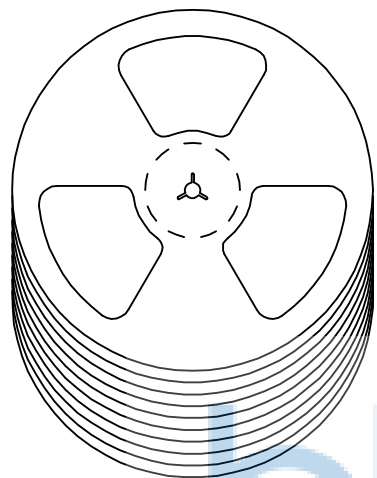

备注:

1. 包装数量: 1000/PCS/卷, 10卷/箱或15卷/箱。
2. 包装袋长度: 每卷前后各空10-20个空格, 中间包装。
3. 材质:
载体: 聚丙烯 (PS), 阻抗 $10^{6-9} \Omega$
上带: 聚乙烯 (PET), 阻抗 $10^{6-11} \Omega$
卷盘: 聚苯乙烯。

纸箱规格: 345*345*23MM

纸箱规格: 345*345*35MM

THIS DOCUMENT IS THE SOLE PROPERTY OF BBJconn Technology Co.,Ltd. Corporation AND SHOULD NOT BE USED IN WHOLE OR IN PART WITHOUT PRIOR WRITTEN PERMISSION.		深圳市步步精科技有限公司 .X: ±0.38 .X': ±3" .XX: ±0.25 .X': ±2" .XXX: ±0.13 .XX': ±1"		NAME: 3.5耳机座 有头 沉板1.0 六脚贴 四节 (PJ35A043-F06G1BR-E)	
APPD.	JM_Zheng	23/05'02	PJ. NO.: PJ.03.22-01-3021 SIZE: A4 DRW NO.:		
CHKD.	LYX	23/05'02	FINISH: SEE NOTES		MAT'L.: SEE NOTES
PDWG.NO:	0076-1	DR.	SGF	23/05'02	SCALE: N/A REV.: A0 UNIT: mm PAGE: 1/1