

REV.	ECN NO.	CONTENT	DATE	ENGINEER
A0				

1. 技术参数:
- 1.1 额定电流: 0.5A AC/DC
 - 1.2 额定电压: 50V
 - 1.3 耐电压: 500V ACminute
 - 1.4 接触电阻: 20mΩ MAX
 - 1.5 绝缘电阻: 100MΩ MIN
 - 2. 工作温度: -25℃~+85℃

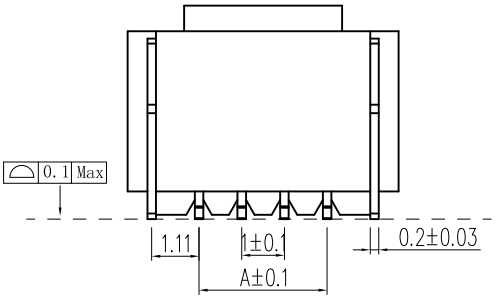

Circuits	Dimensions (mm)			Circuits	Dimensions (mm)		
	A	B	C		A	B	C
1. OLT-2P	1.0	2.6	4.30	1. OLT-12P	11.0	12.6	14.30
1. OLT-3P	2.0	3.6	5.30	1. OLT-13P	12.0	13.6	15.30
1. OLT-4P	3.0	4.6	6.30	1. OLT-14P	13.0	14.6	16.30
1. OLT-5P	4.0	5.6	7.30	1. OLT-15P	14.0	15.6	17.30
1. OLT-6P	5.0	6.6	8.30	1. OLT-16P	15.0	16.6	18.30
1. OLT-7P	6.0	7.6	9.30				
1. OLT-8P	7.0	8.6	10.30				
1. OLT-9P	8.0	9.6	11.30				
1. OLT-10P	9.0	10.6	12.30				
1. OLT-11P	10.0	11.6	13.30				

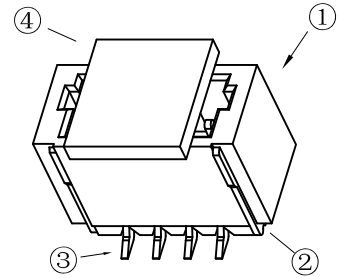
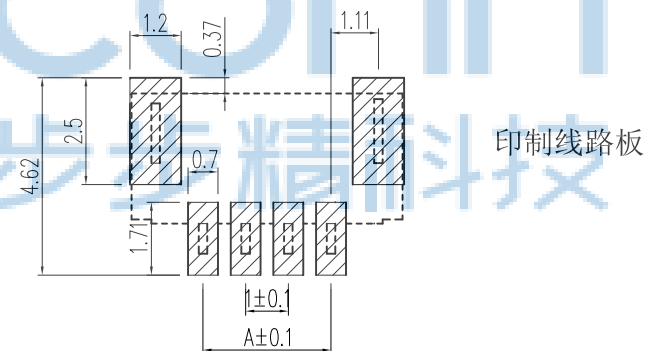
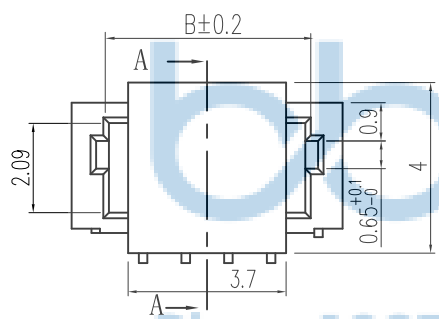
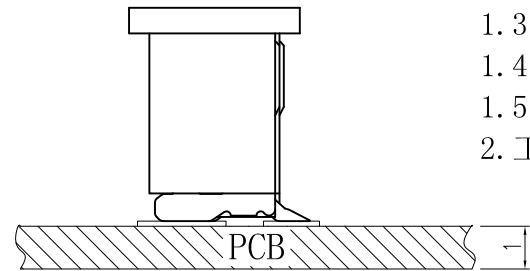
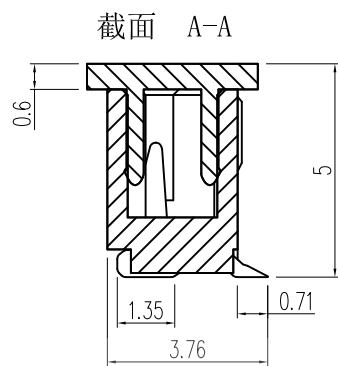
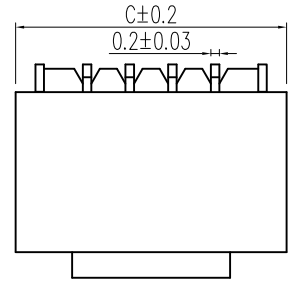

NO	物料名称	规格型号	数量(PCS)	材质	镀涂
①	基座	1.0	1	LCPE130i	本色
②	焊片	1.0	2	磷铜	锡
③	插针	1.0	2~20	磷铜	锡
④	盖板	1.0	1	LCPE130i	本色

THIS DOCUMENT IS THE SOLE PROPERTY OF BBJconn Technology Co., Ltd. Corporation AND SHOULD NOT BE USED IN WHOLE OR IN PART WITHOUT PRIOR WRITTEN PERMISSION.

PDWG.NO: 0013-1

APPD. JM_Zheng

CHKD. LYX

DR. SGF

NAME: 针座 1.0-9P 立贴 加盖 米黄色

PJ. NO.: WT.01.61-85-H001

SIZE: A4 | DRW NO.:

FINISH: SEE NOTES | MAT'L.: SEE NOTES

SCALE: N/A | REV.: A0 | UNIT: mm | PAGE: 1/2

REV.	ECN NO	CONTENT	DATE	ENGINEER
A0				

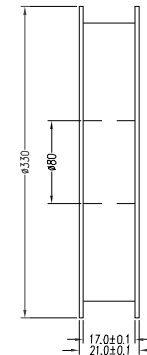
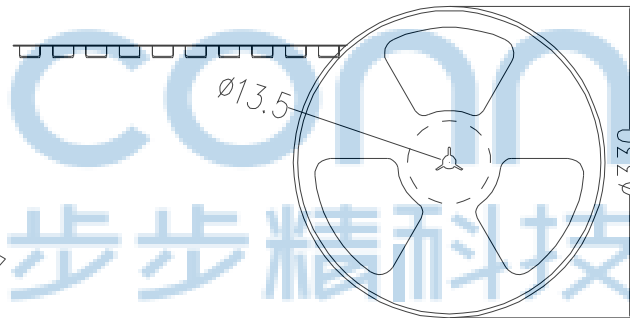
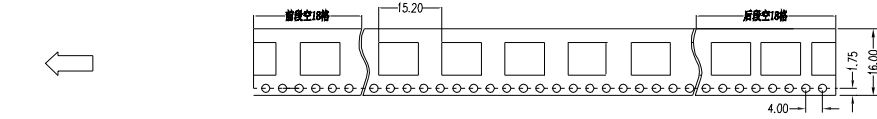
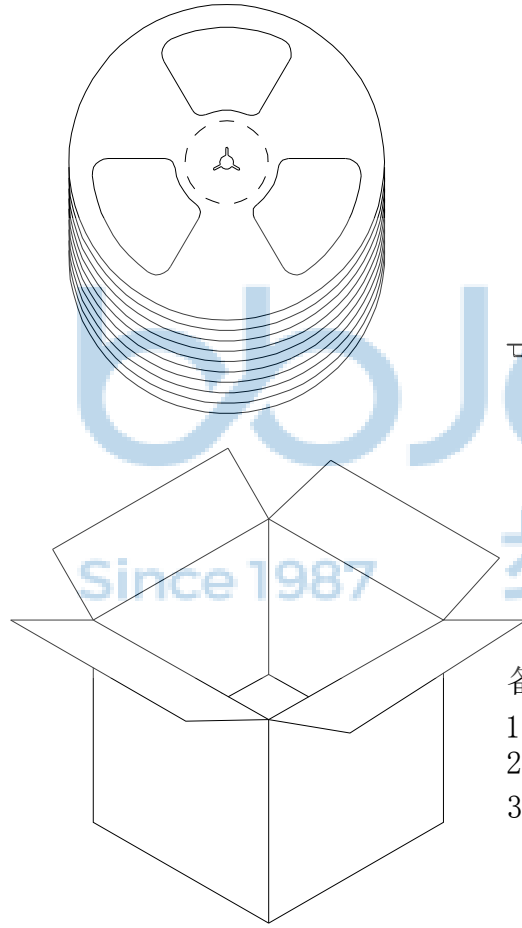

1500 /PCS卷

备注:

1. 包装数量: 1500 /PCS/卷, 10卷/箱或15卷/箱。
2. 包装袋长度: 每卷前后各空30个空格, 中间包装。
3. 材质:
载体: 聚丙烯 (PS), 阻抗 $10^{6-9} \Omega$
上带: 聚乙烯 (PET), 阻抗 $10^{6-11} \Omega$
卷盘: 聚苯乙烯。

纸箱规格: 345*345*23MM

纸箱规格: 345*345*35MM

THIS DOCUMENT IS THE SOLE PROPERTY OF BBJconn Technology Co.,Ltd. Corporation AND SHOULD NOT BE USED IN WHOLE OR IN PART WITHOUT PRIOR WRITTEN PERMISSION.		深圳市步步精科技有限公司 .X: ±0.38 .XX: ±0.25 .XXX: ±0.13 X': ±3' X'': ±2' XX': ±1'		NAME: 针座 1.0-9P 立贴 加盖 米黄色	
APPD.	JM_Zheng	PJ. NO.: WT.01.61-85-H001 SIZE: A4 DRW NO.:		FINISH: SEE NOTES MAT'L.: SEE NOTES	
CHKD.	LYX	SCALE: N/A		REV.: A0	UNIT: mm
PDWG.NO:	0013-1	DR.	SGF	PAGE: 2/2	