

1. 技术参数:
- 1.1 额定电流: 2.0A AC/DC
  - 1.2 额定电压: 250V
  - 1.3 耐电压: 1000V ACminute
  - 1.4 接触电阻: 20mΩ MAX
  - 1.5 绝缘电阻: 1000MΩ MIN
2. 工作温度: -25℃ ~ +85℃

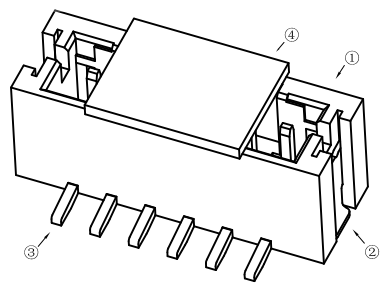
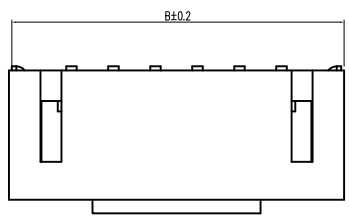
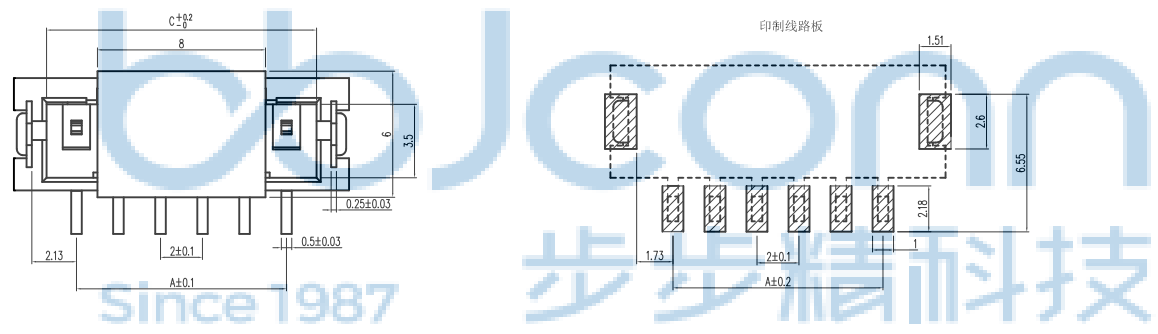
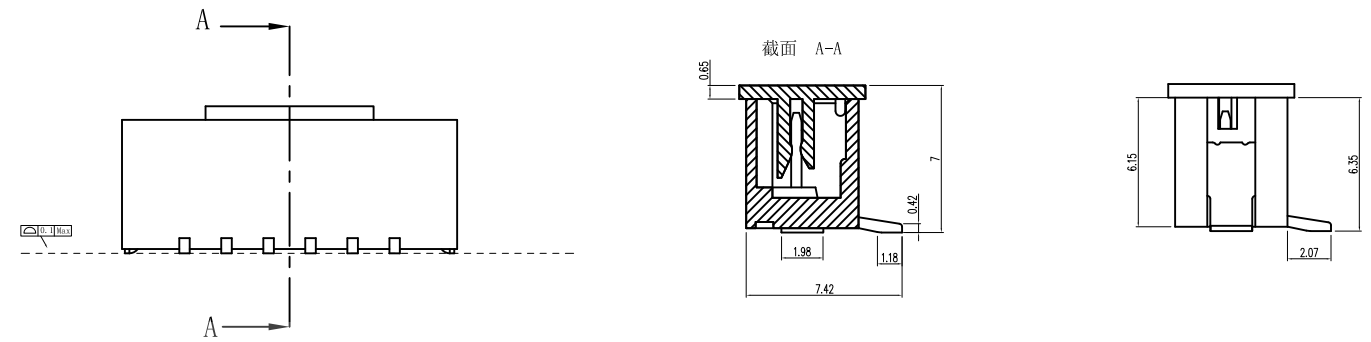

Circuits	Dimensions (mm)			Circuits	Dimensions (mm)		
	A	B	C		A	B	C
2.0LT-2P	2.0	7.90	4.85	2.0LT-12P	22.0	27.9	24.85
2.0LT-3P	4.0	9.90	6.85	2.0LT-13P	24.0	29.9	26.85
2.0LT-4P	6.0	11.90	8.85	2.0LT-14P	26.0	31.9	28.85
2.0LT-5P	8.0	13.90	10.85	2.0LT-15P	28.0	33.9	30.85
2.0LT-6P	10.0	15.90	12.85	2.0LT-16P	30.0	35.9	32.85
2.0LT-7P	12.0	17.90	14.85				
2.0LT-8P	14.0	19.90	16.85				
2.0LT-9P	16.0	21.90	18.85				
2.0LT-10P	18.0	23.90	20.85				
2.0LT-11P	20.0	25.90	22.85				

NO	物料名称	规格型号	数量(PCS)	材质	镀涂
①	基座	2.0	1	LCPE130i	本色
②	焊片	2.0	2	黄铜	锡
③	插针	2.0	2~20	黄铜	锡
④	盖板	2.0	1	LCPE130i	本色

THIS DOCUMENT IS THE SOLE PROPERTY OF BBJconn Technology Co.,Ltd. CORPORATION AND SHOULD NOT BE USED IN WHOLE OR IN PART WITHOUT PRIOR WRITTEN PERMISSION.

PDWG.NO: 0013-1

DR. SGF

APPD. JM\_Zheng

CHKD. LYX

NAME: 针座 2.0-3P 立贴 加盖 米黄色

PJ. NO.: WT.01.61-85-H006

SIZE: A4 | DRW NO.:

FINISH: SEE NOTES | MAT'L.: SEE NOTES

SCALE: N/A | REV.: A0 | UNIT: mm | PAGE: 1/2

**深圳市步步精科技有限公司**

REV.	ECN NO	CONTENT	DATE	ENGINEER
A0				

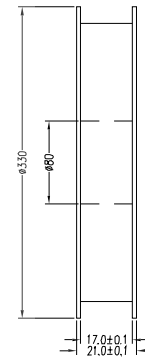
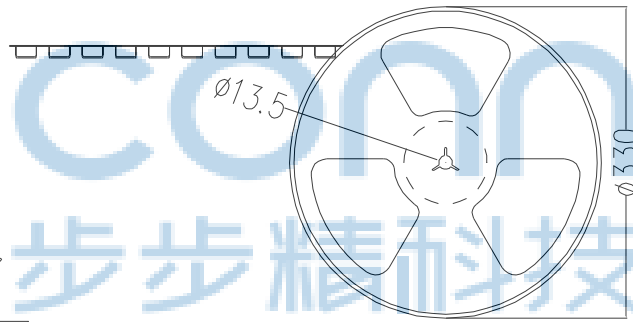
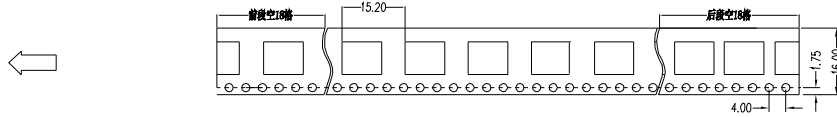
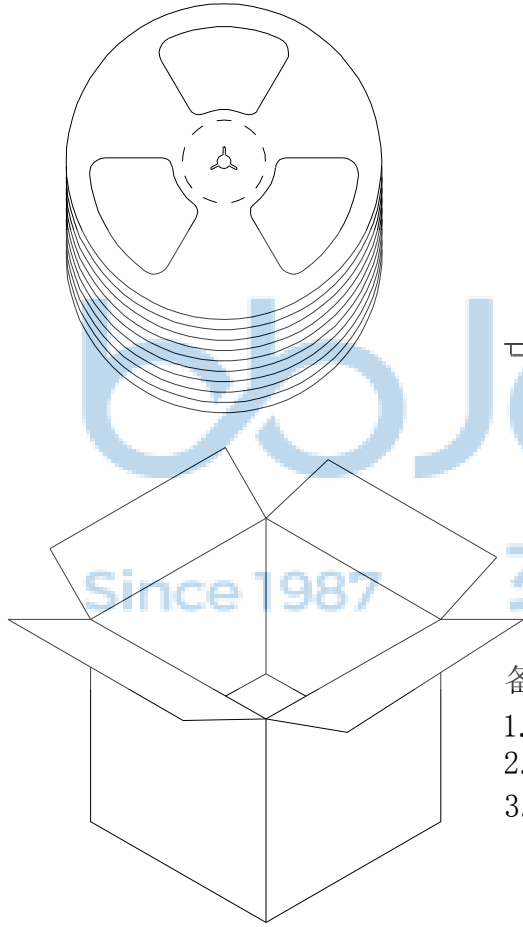

700 /PCS卷

备注:

1. 包装数量: 700 /PCS/卷, 10卷/箱或15卷/箱。
2. 包装袋长度: 每卷前后各空22-22个空格, 中间包装。
3. 材质:  
载体: 聚丙烯 (PS), 阻抗 $10^{6-9} \Omega$   
上带: 聚乙烯 (PET), 阻抗 $10^{6-11} \Omega$   
卷盘: 聚苯乙烯。

纸箱规格: 345\*345\*23MM

纸箱规格: 345\*345\*35MM

THIS DOCUMENT IS THE SOLE PROPERTY OF BBJconn Technology Co.,Ltd. Corporation AND SHOULD NOT BE USED IN WHOLE OR IN PART WITHOUT PRIOR WRITTEN PERMISSION.		深圳市步步精科技有限公司 .X: ±0.38    .X': ±3' .XX: ±0.25    .X': ±2' .XXX: ±0.13    .XX': ±1'		NAME: 针座 2.0-3P 立贴 加盖 米黄色	
APPD.	JM_Zheng	PJ. NO.: WT.01.61-85-H006 SIZE: A4   DRW NO.:		FINISH: SEE NOTES   MAT'L.: SEE NOTES	
CHKD.	LYX	SCALE: N/A		REV.: A0	UNIT: mm
PDWG.NO:	0013-1	DR.	SGF	PAGE: 2/2	