

REV.	ECN NO	CONTENT	DATE	ENGINEER
A0				

1. 技术参数:
- 1.1 额定电流: 1.0A AC/DC
 - 1.2 额定电压: 125V
 - 1.3 耐电压: 500V ACminute
 - 1.4 接触电阻: 20mΩ MAX
 - 1.5 绝缘电阻: 500MΩ MIN
2. 工作温度: -25℃~+85℃

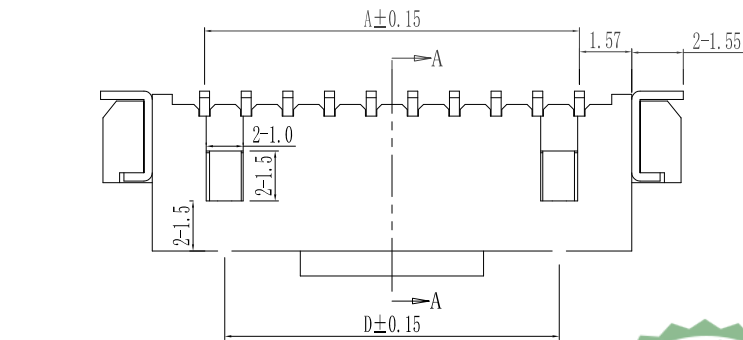

1.25-2PIN立贴一个开槽

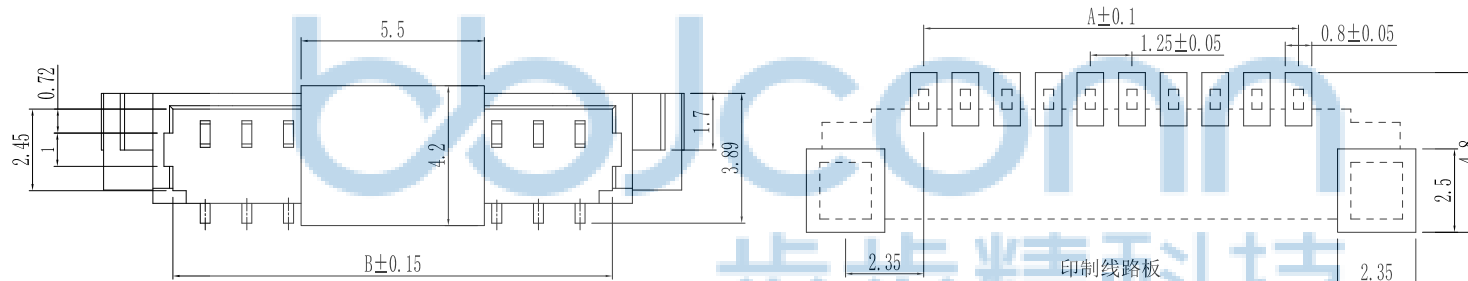
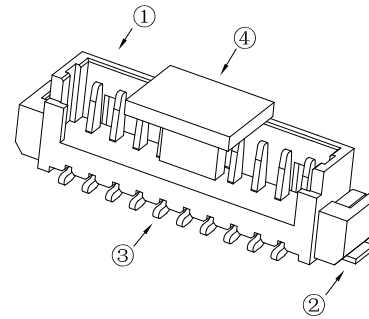
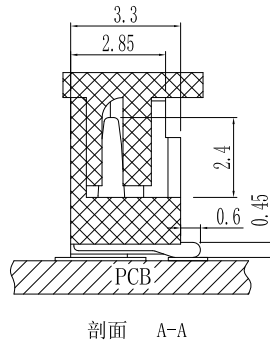
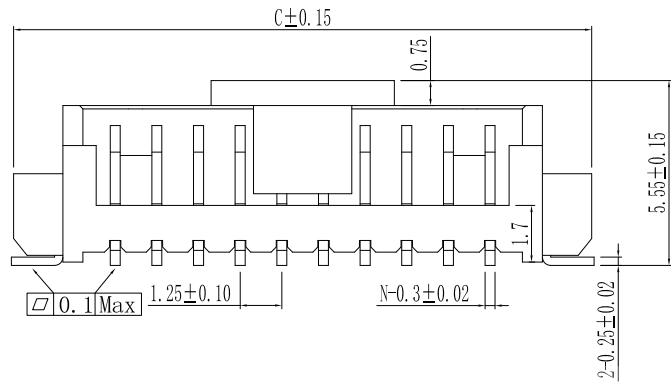
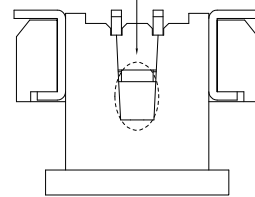

1.25-3PIN立贴一个开槽

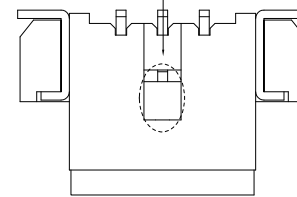

Circuits	Dimensions (mm)			
	A	B	C	D
2PIN	1.25	3.10	7.30	/
3PIN	2.50	4.35	8.55	/
4PIN	3.75	5.60	9.80	2.50
5PIN	5.00	6.85	11.10	3.75
6PIN	6.25	8.10	12.30	5.00
7PIN	7.50	9.35	13.60	6.25
8PIN	8.75	10.60	14.90	7.50
9PIN	10.00	11.85	16.10	8.75
10PIN	11.25	13.10	17.35	10.00
11PIN	12.50	14.35	18.60	11.25
12PIN	13.75	15.60	19.85	12.50
13PIN	15.00	16.85	21.10	13.75
14PIN	16.25	18.10	22.35	15.00
15PIN	17.50	19.35	23.60	16.25
16PIN	18.75	20.60	24.85	17.50

NO	物料名称	数量 (PCS)	材质	镀涂
①	塑胶件	1 PCS	LCP	本色
②	焊片	2 PCS	黄铜 H65	雾锡
③	PIN针	2~16 PCS	黄铜 H65	雾锡
④	盖板	1 PCS	LCP	本色

Since 1987

步步精科技



THIS DOCUMENT IS THE SOLE PROPERTY OF BBJconn Technology Co.,Ltd. Corporation AND SHOULD NOT BE USED IN WHOLE OR IN PART WITHOUT PRIOR WRITTEN PERMISSION. PDWG.NO: 0013-1

深圳市步步精科技有限公司

NAME: 针座 1.25-5P 立贴 雾锡 带加持盖 闭口 隔栏连胶

PJ. NO.: WT.04.65-85-H006

SIZE: A4 DRW NO.:

FINISH: SEE NOTES MAT'L.: SEE NOTES

SCALE: N/A REV.: A0 UNIT: mm PAGE: 1/2

APPD. JM_Zheng

CHKD. LYX

DR. SGF

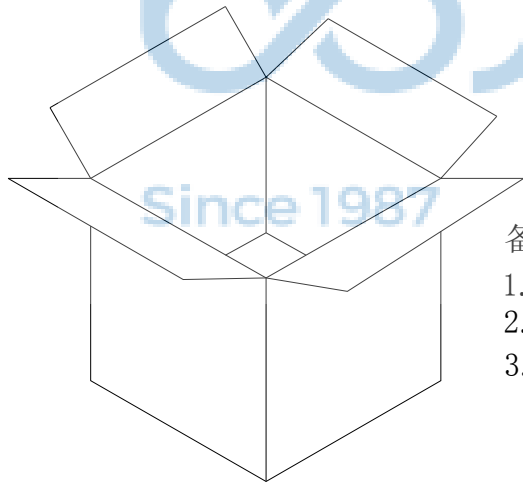
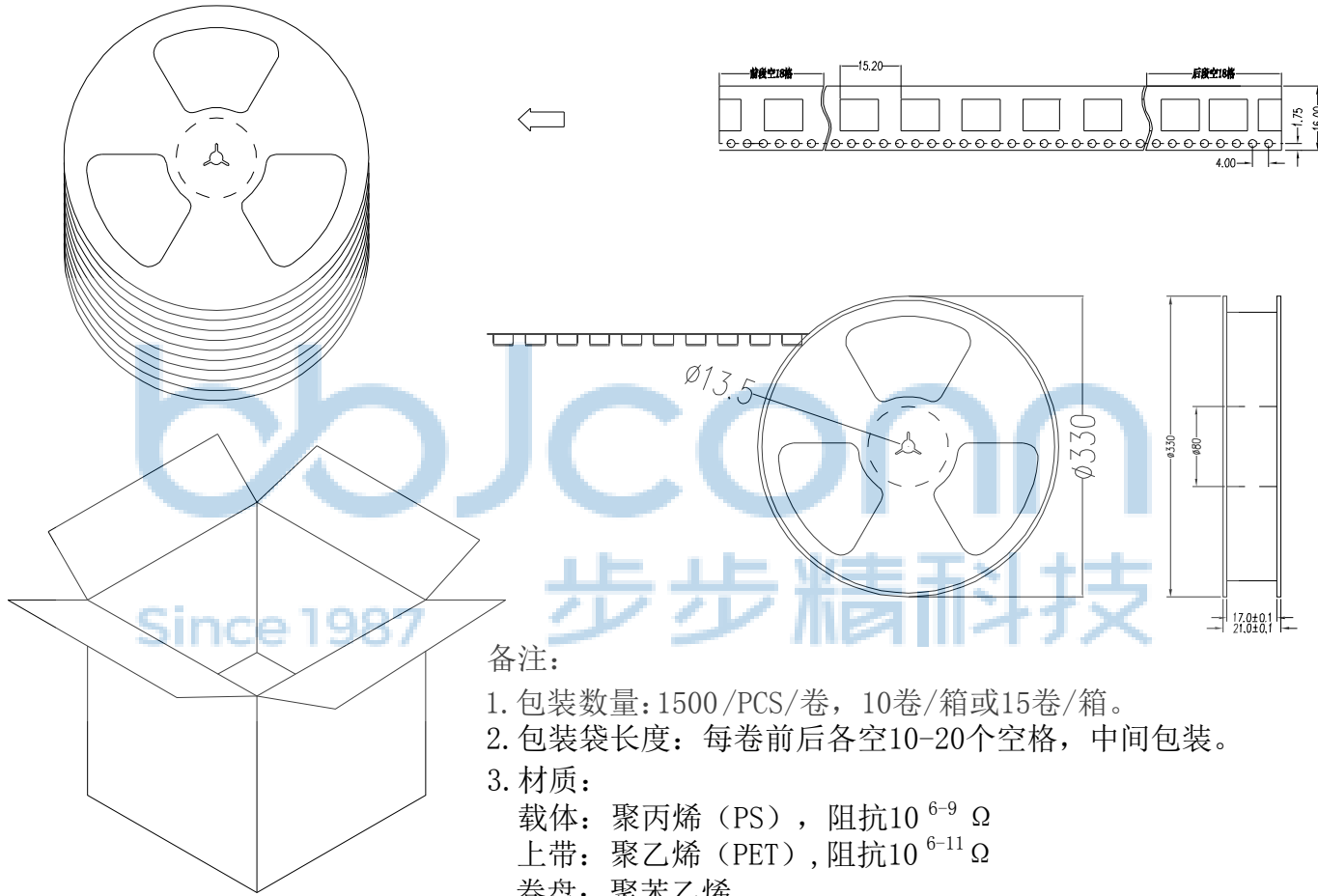

备注:

1. 包装数量: 1500 /PCS/卷, 10卷/箱或15卷/箱。
2. 包装袋长度: 每卷前后各空10-20个空格, 中间包装。
3. 材质:
载体: 聚丙烯 (PS), 阻抗 $10^{6-9} \Omega$
上带: 聚乙烯 (PET), 阻抗 $10^{6-11} \Omega$
卷盘: 聚苯乙烯。

纸箱规格: 345*345*23MM
纸箱规格: 345*345*35MM



THIS DOCUMENT IS THE SOLE PROPERTY OF BBJconn Technology Co.,Ltd. Corporation AND SHOULD NOT BE USED IN WHOLE OR IN PART WITHOUT PRIOR WRITTEN PERMISSION.		深圳市步步精科技有限公司 .X: ±0.38 .X': ±3" .XX: ±0.25 .X': ±2" .XXX: ±0.13 .XX': ±1"		NAME: 针座 1.25-5P 立贴 雾锡 带加遮盖 闭口 隔栏连胶	
APPD.	JM_Zheng	PJ. NO.: WT.04.65-85-H006 SIZE: A4 DRW NO.:		FINISH: SEE NOTES MAT'L.: SEE NOTES	
CHKD.	LYX	SCALE: N/A		REV.: A0	UNIT: mm
PDWG.NO:	0013-1	DR.	SGF	PAGE: 2/2	