

REV.	ECN NO.	CONTENT	DATE	ENGINEER
A0				

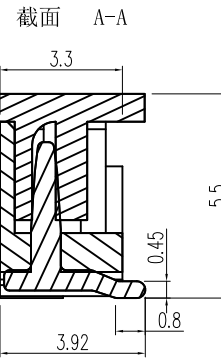

1. 技术参数:
- 1.1 额定电流: 1.0A AC/DC
 - 1.2 额定电压: 125V
 - 1.3 耐电压: 500V ACminute
 - 1.4 接触电阻: 20mΩ MAX
 - 1.5 绝缘电阻: 500MΩ MIN
2. 工作温度: -25℃~+85℃

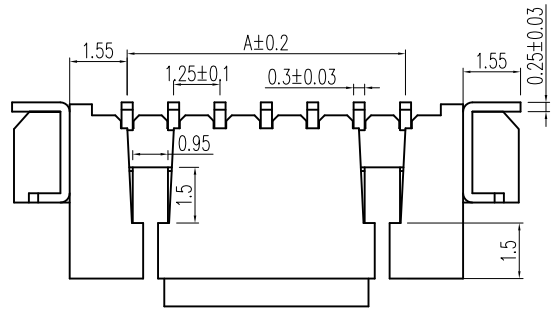
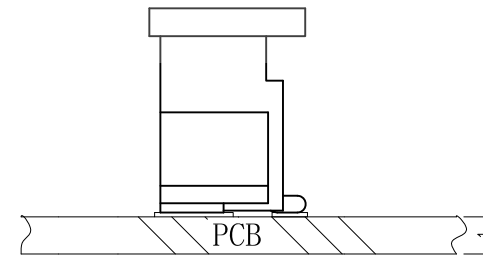
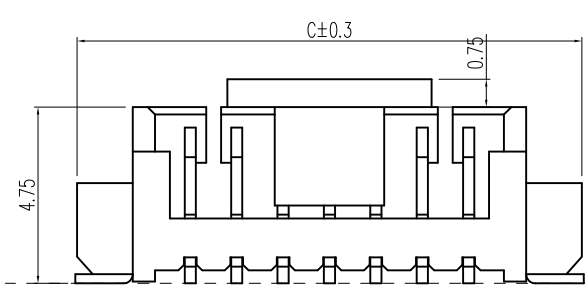
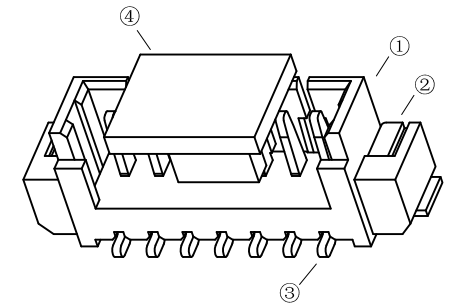
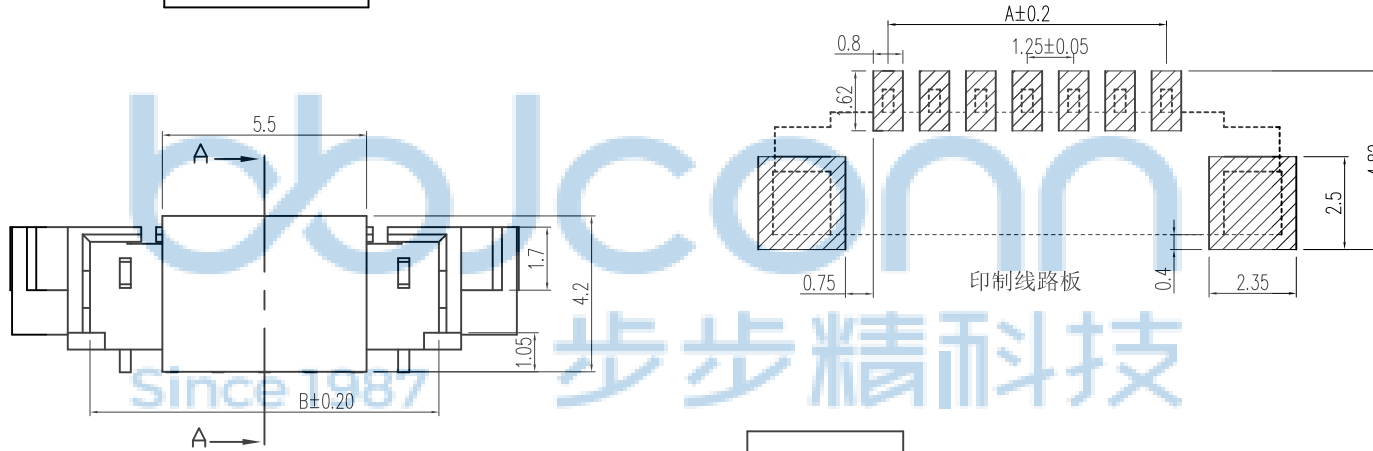

Circuits	Dimensions (mm)			Circuits	Dimensions (mm)		
	A	B	C		A	B	C
1. 25LT-2P	1.25	3.10	7.30	1. 25LT-12P	13.75	15.60	19.85
1. 25LT-3P	2.50	4.35	8.60	1. 25LT-13P	15.00	16.85	21.10
1. 25LT-4P	3.75	5.60	9.80	1. 25LT-14P	16.25	18.10	22.35
1. 25LT-5P	5.00	6.85	11.10	1. 25LT-15P	17.50	19.35	23.60
1. 25LT-6P	6.25	8.10	12.30	1. 25LT-16P	18.75	20.60	24.85
1. 25LT-7P	7.50	9.35	13.60				
1. 25LT-8P	8.75	10.60	14.90				
1. 25LT-9P	10.00	11.85	16.10				
1. 25LT-10P	11.25	13.10	17.30				
1. 25LT-11P	12.50	14.35	18.60				

NO	物料名称	规格型号	数量 (PCS)	材质	镀涂
①	基座	1.25	1	LCPE130i	本色
②	焊片	1.25	2	黄铜	锡
③	插针	1.25	2~20	黄铜	锡
④	盖板	1.25	1	LCPE130i	本色



THIS DOCUMENT IS THE SOLE PROPERTY OF BBJconn Technology Co., Ltd. CORPORATION AND SHOULD NOT BE USED IN WHOLE OR IN PART WITHOUT PRIOR WRITTEN PERMISSION.

PDWG.NO: 0050-2

深圳市步步精科技有限公司

NAME: 针座 1.25-13P 立贴 加盖 米黄色

PJ. NO.: WT.04.61-85-M012

SIZE: A4 | DRW NO.:

FINISH: SEE NOTES | MAT'L.: SEE NOTES

SCALE: N/A | REV.: A0 | UNIT: mm | PAGE: 1/2

APPD. JM_Zheng

CHKD. LYX

DR. SGF

REV.	ECN NO	CONTENT	DATE	ENGINEER
A0				

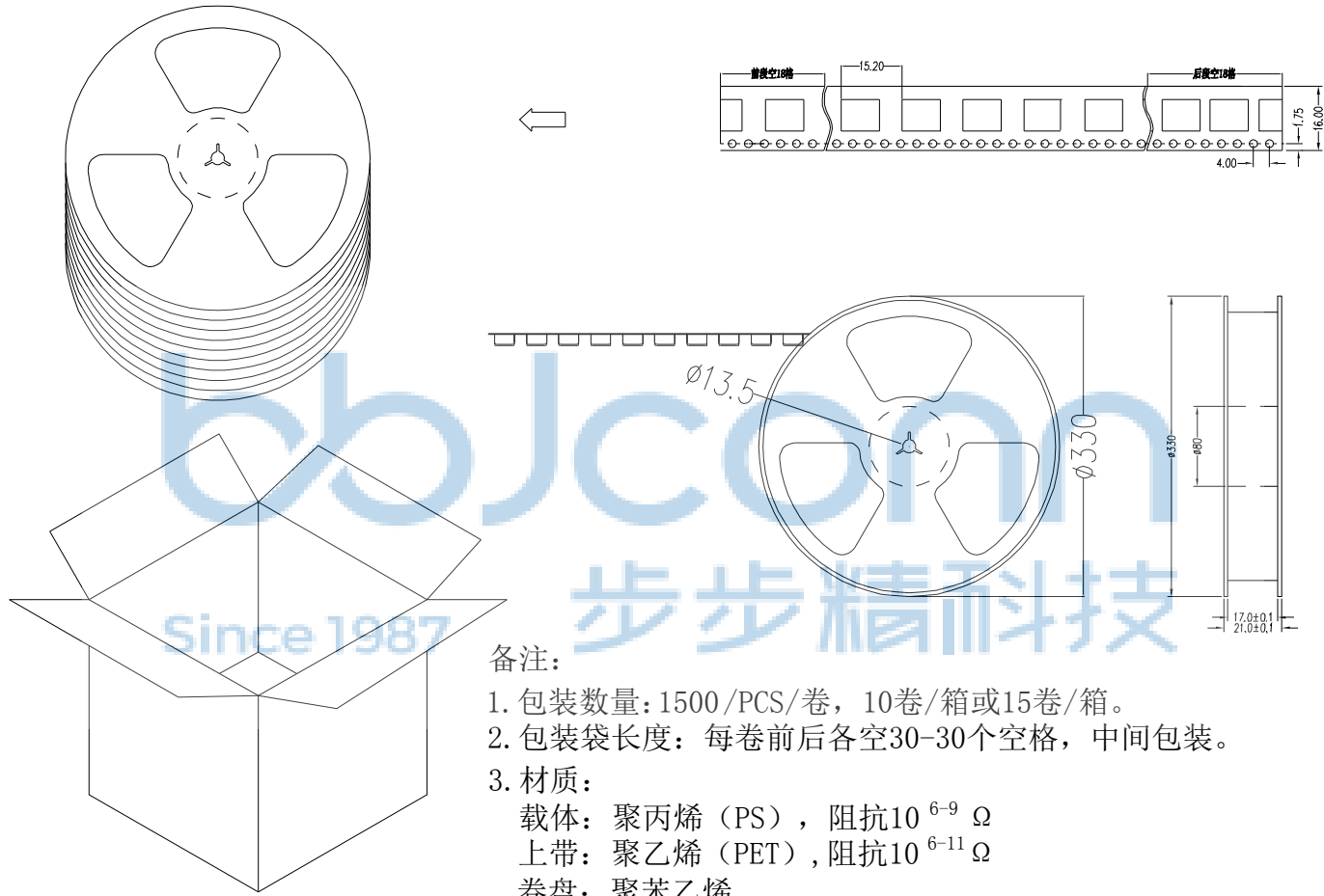

- 备注:
1. 包装数量: 1500 /PCS/卷, 10卷/箱或15卷/箱。
 2. 包装袋长度: 每卷前后各空30-30个空格, 中间包装。
 3. 材质:
 载体: 聚丙烯 (PS), 阻抗 $10^{6-9} \Omega$
 上带: 聚乙烯 (PET), 阻抗 $10^{6-11} \Omega$
 卷盘: 聚苯乙烯。
- 纸箱规格: 345*345*23MM
 纸箱规格: 345*345*35MM

THIS DOCUMENT IS THE SOLE PROPERTY OF BBJconn Technology Co.,Ltd. Corporation AND SHOULD NOT BE USED IN WHOLE OR IN PART WITHOUT PRIOR WRITTEN PERMISSION.		深圳市步步精科技有限公司 .X: ±0.38 .X': ±3" .XX: ±0.25 .X': ±2" .XXX: ±0.13 .XX': ±1"		NAME: 针座 1.25-13P 立贴 加盖 米黄色	
APPD.	JM_Zheng	PJ. NO.: WT.04.61-85-M012		SIZE: A4 DRW NO.:	
CHKD.	LYX	FINISH: SEE NOTES		MAT'L.: SEE NOTES	
PDWG.NO:	0050-2	DR.	SGF	SCALE: N/A	REV.: A0
				UNIT: mm	PAGE: 2/2