

REV.	ECN NO	CONTENT	DATE	ENGINEER
A0				

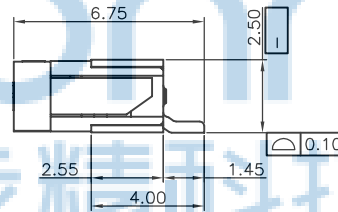

CKTS	DIM A	DIM B	DIM C	DIM D
4	3.00	5.10	9.05	11.00
5	4.00	6.10	10.05	12.00
6	5.00	7.10	11.05	13.00
7	6.00	8.10	12.05	14.00
8	7.00	9.10	13.05	15.00
9	8.00	10.10	14.05	16.00
10	9.00	11.10	15.05	17.00
11	10.00	12.10	16.05	18.00
12	11.00	13.10	17.05	19.00
13	12.00	14.10	18.05	20.00
14	13.00	15.10	19.05	21.00
15	14.00	16.10	20.05	22.00
16	15.00	17.10	21.05	23.00
17	16.00	18.10	22.05	24.00
18	17.00	19.10	23.05	25.00
19	18.00	20.10	24.05	26.00
20	19.00	21.10	25.05	27.00
21	20.00	22.10	26.05	28.00
22	21.00	23.10	27.05	29.00
23	22.00	24.10	28.05	30.00
24	23.00	25.10	29.05	31.00
25	24.00	26.10	30.05	32.00
26	25.00	27.10	31.05	33.00
27	26.00	28.10	32.05	34.00
28	27.00	29.10	33.05	35.00
29	28.00	30.10	34.05	36.00
30	29.00	31.10	35.05	37.00

- Note:
- Material:
 - Housing: thermoplastic high temp.UL94V-0; Color: natural.
 - Latch: thermoplastic high temp.UL94V-0; Color: black.
 - Terminal: copper alloy.
 - Fitting Nail: copper alloy.
 - Finish:
 - Terminal: Underplating: Au/matt Tin overall.
 - Fitting Nail: Underplating: matt Tin overall.
 - Product must complv HF RoHS specification

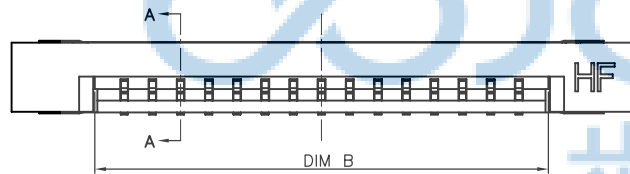
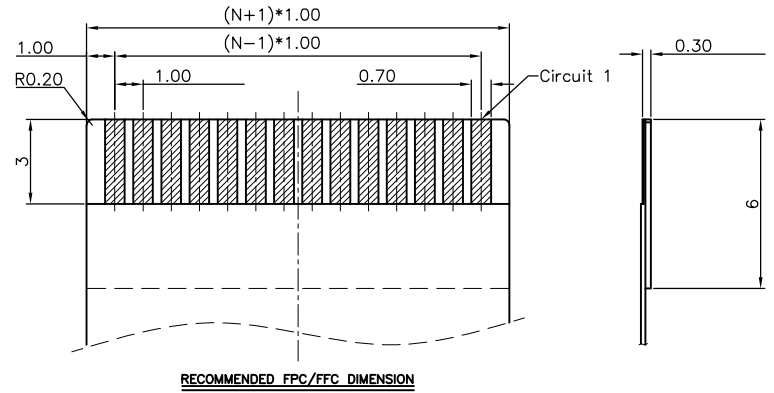
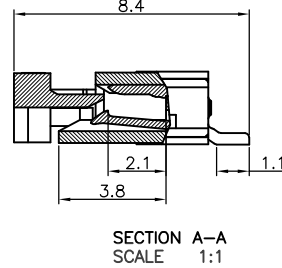
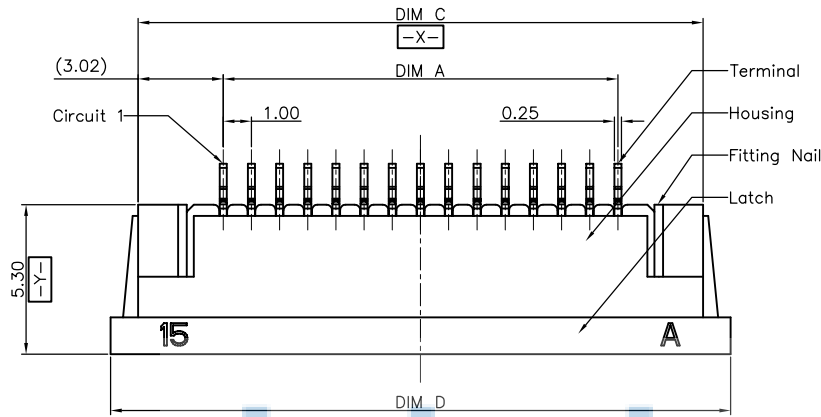
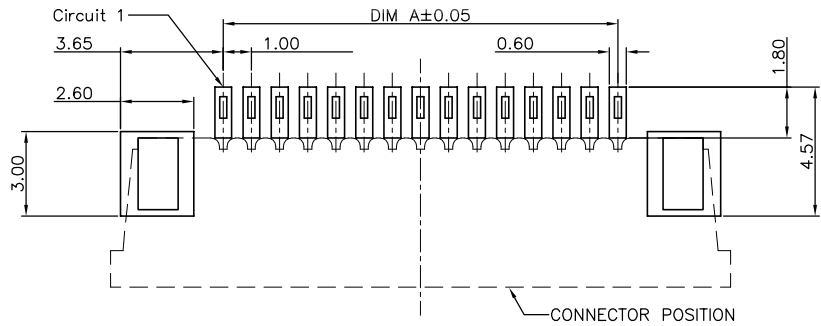

RECOMMENDED P.C.B PATTERN LAYOUT



THIS DOCUMENT IS THE SOLE PROPERTY OF BBJconn Technology Co.,Ltd. Corporation AND SHOULD NOT BE USED IN WHOLE OR IN PART WITHOUT PRIOR WRITTEN PERMISSION.		深圳市步步精科技有限公司 NAME: FPC连接器1.0-4P抽拉下接H2.5	
APPD.	JM_Zheng	PJ. NO.: PC.04.02-42-C002 SIZE: A4 DRW NO.:	FINISH: SEE NOTES MAT'L.: SEE NOTES SCALE: N/A REV.: A0 UNIT: mm PAGE: 1/2
CHKD.	LYX		
PDWG.NO:	0407-1	DR.	SGF

REV.	ECN NO	CONTENT	DATE	ENGINEER
A0				

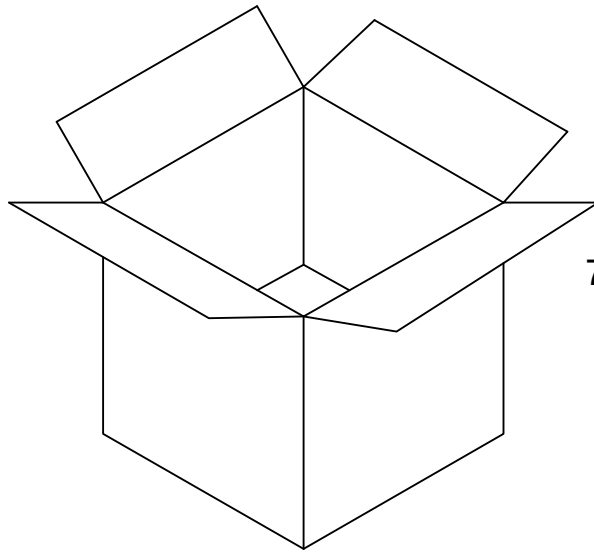
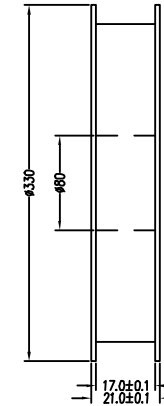
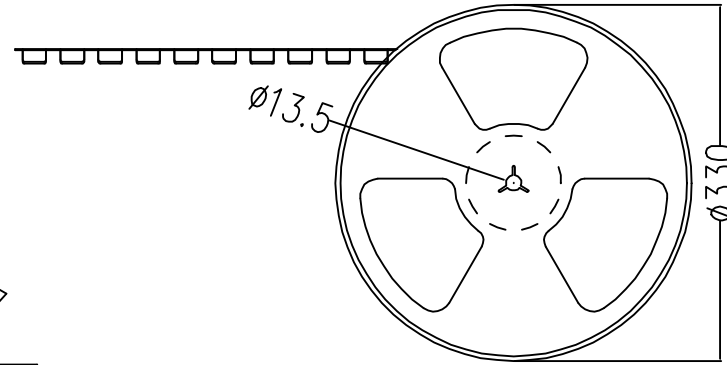
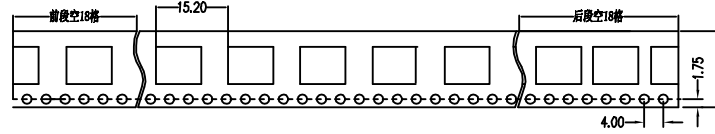
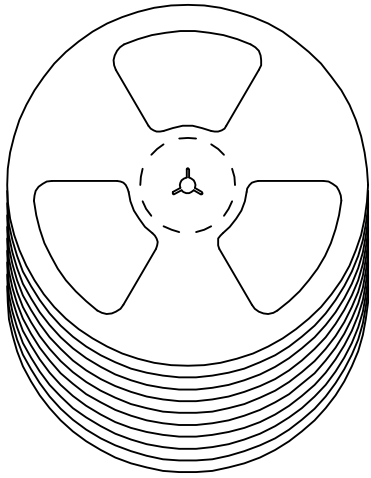

7# Ö
 5>ö Gy Ö 3 & 6 § È § 1á Ä
 5>ö>»K- Ö Ö!y § } > 40^a Z0^a I È]L\$ 5>ö Ä
 €CX Ö
 E- f Ö6Š I' Ä 3 6 Å ÈLk Ç
 : V Ö6Š %' Ä 3 (7 Å Lk Ç
 §- Ö6Š9 %' Ä

4è1á?ô I Ö 00
 4è1á?ô I Ö 00

THIS DOCUMENT IS THE SOLE PROPERTY OF BBJconn Technology Co.,Ltd. Corporation AND SHOULD NOT BE USED IN WHOLE OR IN PART WITHOUT PRIOR WRITTEN PERMISSION.		\$! c 2!•!•2î0 ° 9L€ œ (
.X: ±0.38 X': ±3' .XX: ±0.25 .X': ±2' .XXX: ±0.13 .XX': ±1'		NAME: FPCÁ-½ÓÆ÷1.0-4P³éÄ-Ä½ÖH2.5	
APPD.	JM_Zheng	PJ. NO.: PC.04.02-42-C002	
CHKD.	LYX	SIZE: A4 DRW NO.:	
PDWG.NO:	0407-1	DR.	SGF
		FINISH: SEE NOTES	MAT'L.: SEE NOTES
		SCALE: N/A	REV.: A0 UNIT: mm PAGE: 2/2