

REV.	ECN NO	CONTENT	DATE	ENGINEER
A0				

- FPC NOT MATING CONDITION BANNED CLOSURE
- ALL MATERIAL MUST BE COMPLY WITH ROHS

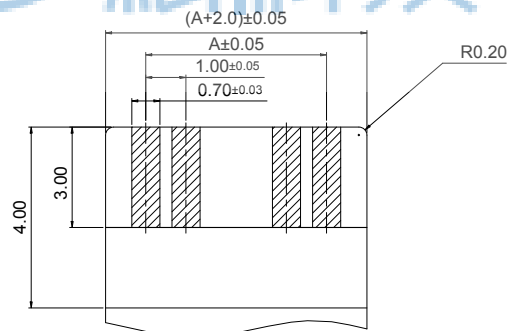
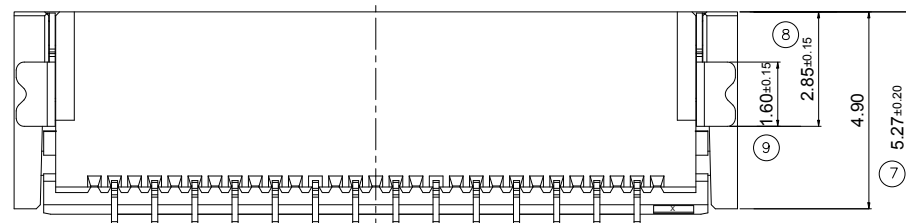
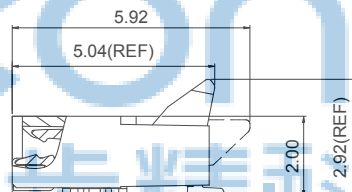
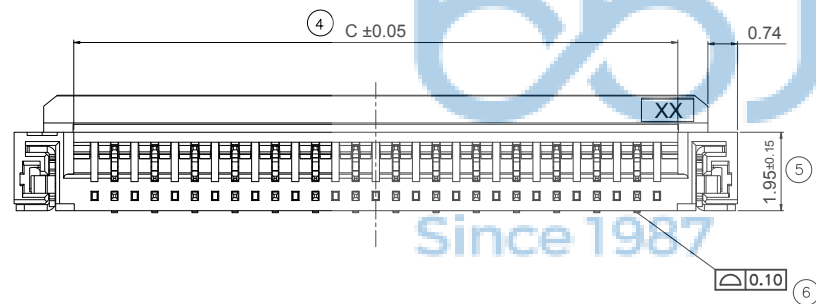
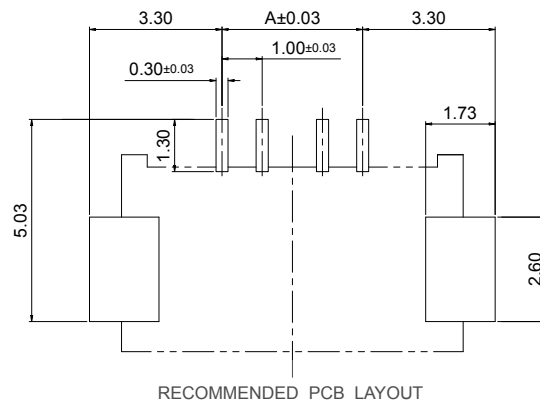
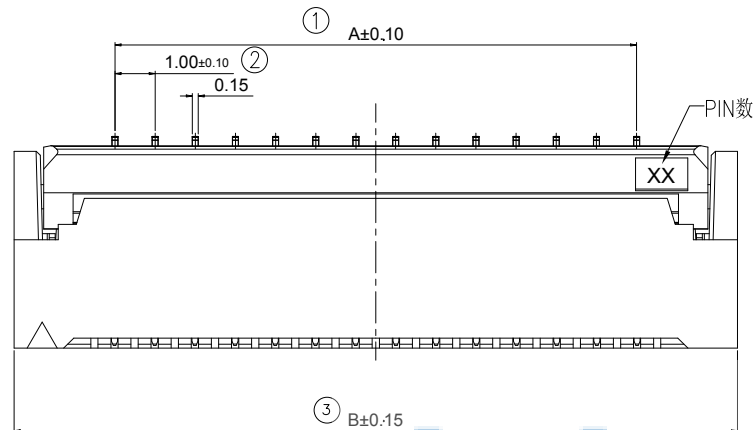

APPLICABLE FPC/FFC
T=0.30±0.03

DIM	A	B	C
4	3.00	8.00	5.05
6	5.00	10.00	7.05
8	7.00	12.00	9.05
9	8.00	13.00	10.05
10	9.00	14.00	11.05
12	11.00	16.00	13.05
15	14.00	19.00	16.05
22	21.00	26.00	23.05
25	24.00	29.00	26.05



THIS DOCUMENT IS THE SOLE PROPERTY OF BBJconn Technology Co.,Ltd. Corporation AND SHOULD NOT BE USED IN WHOLE OR IN PART WITHOUT PRIOR WRITTEN PERMISSION.		深圳市步步精科技有限公司	
PDWG:NO: 0428-1		NAME: FPC 1.0-4P 后翻式 H=2.0 (FB1020)	
APPD. JM_Zheng	CHKD. LYX	PJ. NO.: PC.04.05-32-D001	
DR. TSP		SIZE: A4 DRW NO.:	
		FINISH: SEE NOTES MAT'L.: SEE NOTES	
		SCALE: N/A REV.: A0 UNIT: mm PAGE: 1/2	

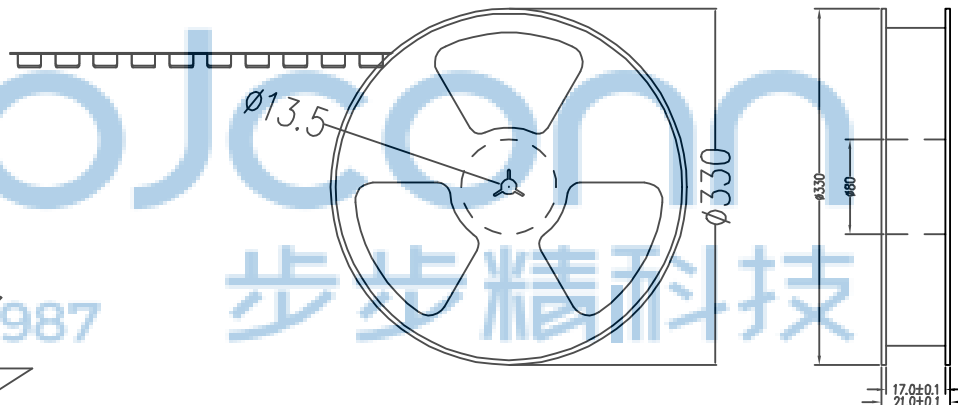
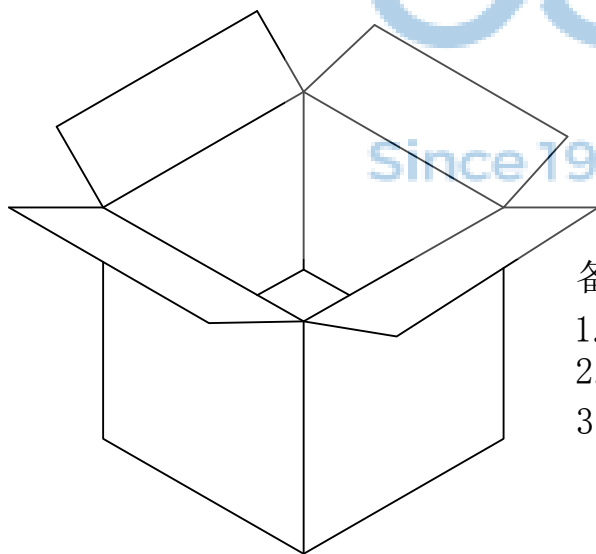
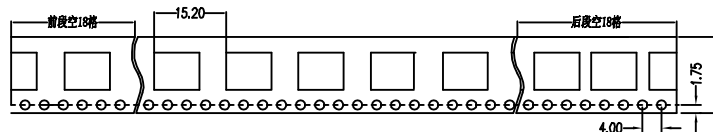
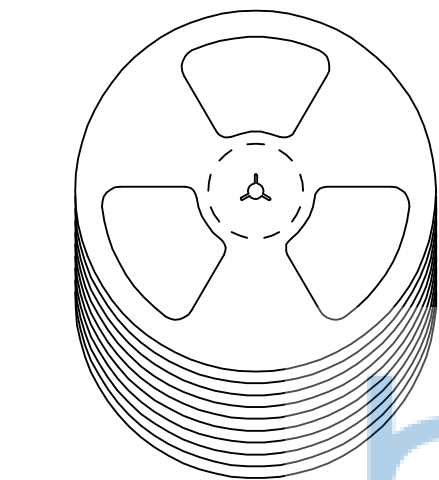

备注:

1. 包装数量: 1500/PCS/卷, 10卷/箱。
2. 包装袋长度: 每卷前后各空10-20个空格, 中间包装。
3. 材质:
载体: 聚丙烯 (PS), 阻抗 $10^{6-9} \Omega$
上带: 聚乙烯 (PET), 阻抗 $10^{6-11} \Omega$
卷盘: 聚苯乙烯。

纸箱规格: 345*345*23MM

纸箱规格: 345*345*35MM

THIS DOCUMENT IS THE SOLE PROPERTY OF BBJconn Technology Co.,Ltd. Corporation AND SHOULD NOT BE USED IN WHOLE OR IN PART WITHOUT PRIOR WRITTEN PERMISSION.		深圳市步步精科技有限公司 .X: ± 0.38 .X': $\pm 3'$.XX: ± 0.25 .X': $\pm 2'$.XXX: ± 0.13 .XX': $\pm 1'$		NAME: FPC 1.0-4P 后翻式 H=2.0 (FB1020)	
APPD.	JM_Zheng	PJ. NO.: PC.04.05-32-D001		SIZE: A4 DRW NO.:	
CHKD.	LYX	FINISH: SEE NOTES		MAT'L.: SEE NOTES	
PDWG.NO:	0428-1	DR.	TSP	SCALE: N/A	REV.: AO UNIT: mm PAGE: 2/2