

| REV. | ECN NO | CONTENT | DATE | ENGINEER |
|------|--------|---------|------|----------|
| A0 | | | | |

Note:

- Material:
 - Housing: thermoplastic high temp.UL94V-0; Color: natural.
 - Latch: thermoplastic high temp.UL94V-0; Color: black.
 - Terminal: copper alloy.
 - Fitting Nail: copper alloy.
- Finsh:
 - Terminal: Underplating: Au/matt Tin overall.
 - Fitting Nail: Underplating: matt Tin overall.
- Product must comply HF RoHS specification.

| CKTS | DTM A | DTM B | DTM C | DTM D |
|------|-------|-------|-------|-------|
| 4 | 1.50 | 2.60 | 4.70 | 6.10 |
| 5 | 2.00 | 3.10 | 5.20 | 6.60 |
| 6 | 2.50 | 3.60 | 5.70 | 7.10 |
| 7 | 3.00 | 4.10 | 6.20 | 7.60 |
| 8 | 3.50 | 4.60 | 6.70 | 8.10 |
| 9 | 4.00 | 5.10 | 7.20 | 8.60 |
| 10 | 4.50 | 5.60 | 7.70 | 9.10 |
| 11 | 5.00 | 6.10 | 8.20 | 9.60 |
| 12 | 5.50 | 6.60 | 8.70 | 10.10 |
| 13 | 6.00 | 7.10 | 9.20 | 10.60 |
| 14 | 6.50 | 7.60 | 9.70 | 11.10 |
| 15 | 7.00 | 8.10 | 10.20 | 11.60 |
| 16 | 7.50 | 8.60 | 10.70 | 12.10 |
| 17 | 8.00 | 9.10 | 11.20 | 12.60 |
| 18 | 8.50 | 9.60 | 11.70 | 13.10 |
| 19 | 9.00 | 10.10 | 12.20 | 13.60 |
| 20 | 9.50 | 10.60 | 12.70 | 14.10 |
| 21 | 10.00 | 11.10 | 13.20 | 14.60 |
| 22 | 10.50 | 11.60 | 13.70 | 15.10 |
| 23 | 11.00 | 12.10 | 14.20 | 15.60 |
| 24 | 11.50 | 12.60 | 14.70 | 16.10 |
| 25 | 12.00 | 13.10 | 15.20 | 16.60 |
| 26 | 12.50 | 13.60 | 15.70 | 17.10 |
| 27 | 13.00 | 14.10 | 16.20 | 17.60 |
| 28 | 13.50 | 14.60 | 16.70 | 18.10 |
| 29 | 14.00 | 15.10 | 17.20 | 18.60 |
| 30 | 14.50 | 15.60 | 17.70 | 19.10 |
| 31 | 15.00 | 16.10 | 18.20 | 19.60 |
| 32 | 15.50 | 16.60 | 18.70 | 20.10 |
| 33 | 16.00 | 17.10 | 19.20 | 20.60 |
| 34 | 16.50 | 17.60 | 19.70 | 21.10 |
| 35 | 17.00 | 18.10 | 20.20 | 21.60 |
| 36 | 17.50 | 18.60 | 20.70 | 22.10 |
| 37 | 18.00 | 19.10 | 21.20 | 22.60 |
| 38 | 18.50 | 19.60 | 21.70 | 23.10 |
| 39 | 19.00 | 20.10 | 22.20 | 23.60 |
| 40 | 19.50 | 20.60 | 22.70 | 24.10 |
| 41 | 20.00 | 21.10 | 23.20 | 24.60 |
| 42 | 20.50 | 21.60 | 23.70 | 25.10 |
| 43 | 21.00 | 22.10 | 24.20 | 25.60 |
| 44 | 21.50 | 22.60 | 24.70 | 26.10 |
| 45 | 22.00 | 23.10 | 25.20 | 26.60 |
| 46 | 22.50 | 23.60 | 25.70 | 27.10 |
| 47 | 23.00 | 24.10 | 26.20 | 27.60 |
| 48 | 23.50 | 24.60 | 26.70 | 28.10 |
| 49 | 24.00 | 25.10 | 27.20 | 28.60 |
| 50 | 24.50 | 25.60 | 27.70 | 29.10 |
| 51 | 25.00 | 26.10 | 28.20 | 29.60 |
| 52 | 25.50 | 26.60 | 28.70 | 30.10 |
| 53 | 26.00 | 27.10 | 29.20 | 30.60 |
| 54 | 26.50 | 27.60 | 29.70 | 31.10 |
| 55 | 27.00 | 28.10 | 30.20 | 31.60 |
| 56 | 27.50 | 28.60 | 30.70 | 32.10 |
| 57 | 28.00 | 29.10 | 31.20 | 32.60 |
| 58 | 28.50 | 29.60 | 31.70 | 33.10 |
| 59 | 29.00 | 30.10 | 32.20 | 33.60 |
| 60 | 29.50 | 30.60 | 32.70 | 34.10 |

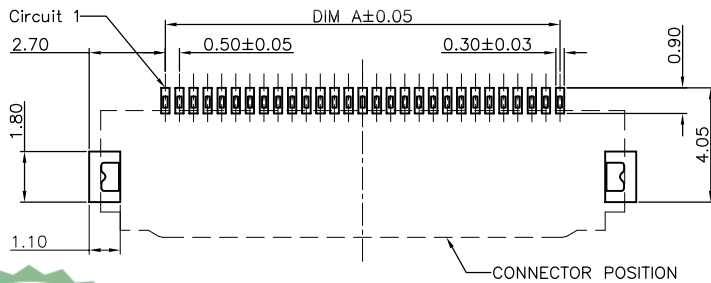
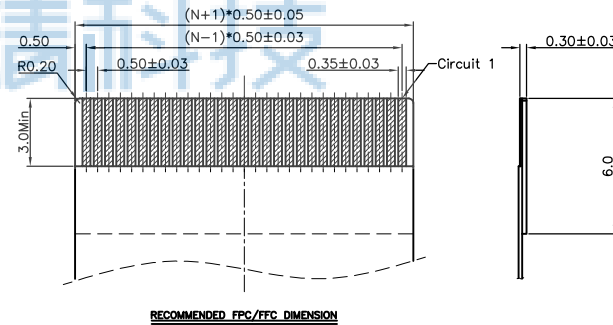
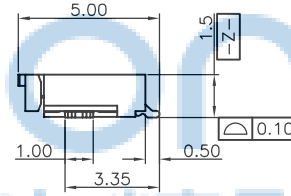
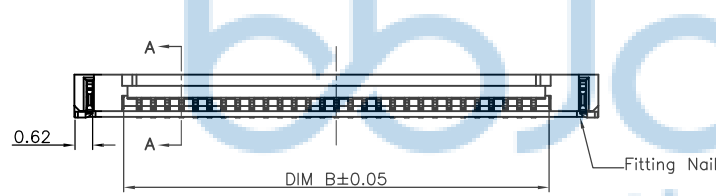
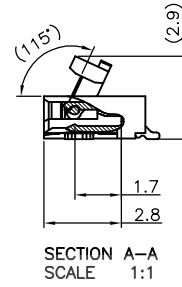
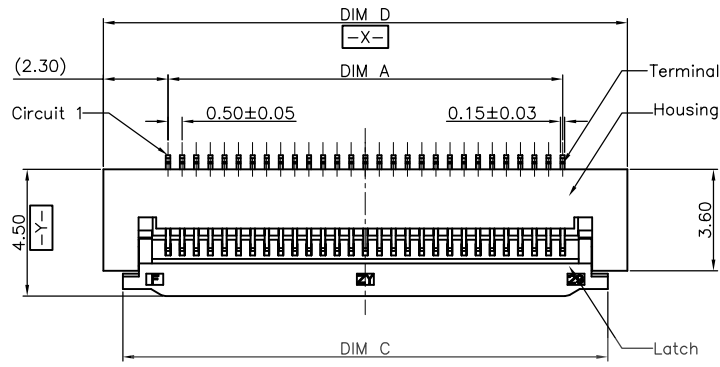

RECOMMENDED P.C.B PATTERN LAYOUT



| | | | |
|--|--|---|--|
| THIS DOCUMENT IS THE SOLE PROPERTY OF BBJconn Technology Co.,Ltd. Corporation AND SHOULD NOT BE USED IN WHOLE OR IN PART WITHOUT PRIOR WRITTEN PERMISSION. | | 深圳市步步精科技有限公司 NAME: FPC 0.5-6P 翻盖下接 H=1.5 APPD. JM_Zheng CHKD. LYX DR. SGF | |
| .X: ±0.38 .XX: ±0.25 .XXX: ±0.13 | | X': ±3' X'': ±2' XX': ±1' | |
| PDWG.NO: 0167-1 | | PJ. NO.: PC.02.04-22-2003 SIZE: A4 DRW NO.: FINISH: SEE NOTES MAT'L.: SEE NOTES SCALE: N/A REV.: A0 UNIT: mm PAGE: 1/2 | |

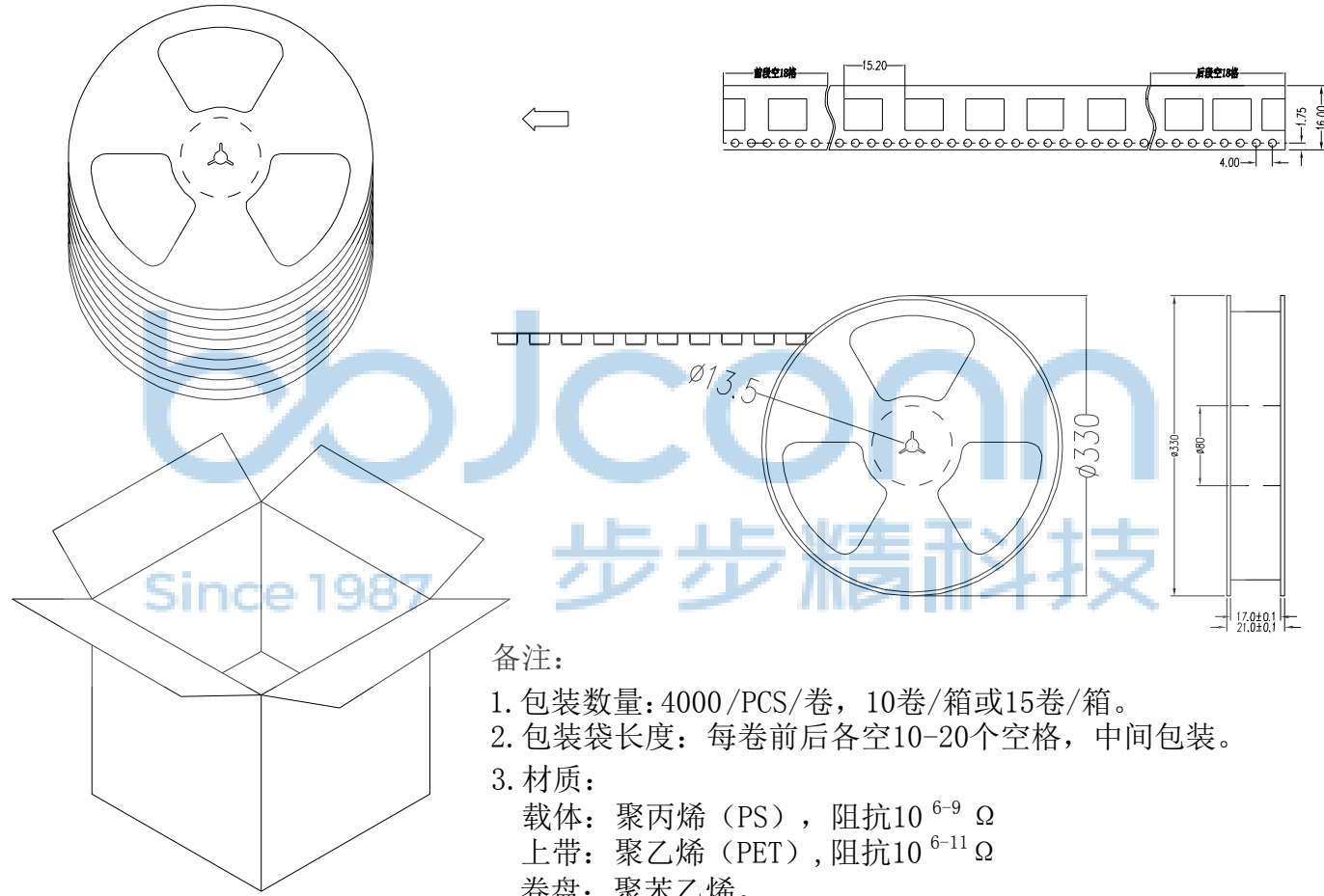

备注：
 1. 包装数量：4000/PCS/卷，10卷/箱或15卷/箱。
 2. 包装袋长度：每卷前后各空10-20个空格，中间包装。
 3. 材质：
 载体：聚丙烯（PS），阻抗 $10^{6-9} \Omega$
 上带：聚乙烯（PET），阻抗 $10^{6-11} \Omega$
 卷盘：聚苯乙烯。
 纸箱规格：345*345*23MM
 纸箱规格：345*345*35MM

| | | | |
|--|----------|--|--|
| THIS DOCUMENT IS THE SOLE PROPERTY OF BBJconn Technology Co.,Ltd. Corporation AND SHOULD NOT BE USED IN WHOLE OR IN PART WITHOUT PRIOR WRITTEN PERMISSION. | | 深圳市步步精科技有限公司 | |
| .X: ±0.38 .XX: ±0.25 .XXX: ±0.13 | | X': ±3' .X': ±2' .XX': ±1' | |
| APPD. | JM_Zheng | NAME: FPC 0.5-6P 翻盖下接 H=1.5 | |
| CHKD. | LYX | PJ. NO.: PC.02.04-22-2003 | |
| DR. | SGF | SIZE: A4 DRW NO.: | |
| PDWG.NO: 0167-1 | | FINISH: SEE NOTES MAT'L.: SEE NOTES | |
| | | SCALE: N/A REV.: A0 UNIT: mm PAGE: 2/2 | |