

REV.	ECN NO.	CONTENT	DATE	ENGINEER
A0				

Note:
 1. Material:
 1.1 Housing: thermoplastic high temp.UL94V-0; Color: natural.
 1.2 Latch: thermoplastic high temp.UL94V-0; Color: black.
 1.3 Terminal: copper alloy.
 1.4 Fitting Nail: copper alloy.
 2. Finish:
 2.1 Terminal:
 Underplating: Au/matt Tin overall.
 2.2 Fitting Nail:
 Underplating: matt Tin overall.
 3. Product must comply HF RoHS specification.

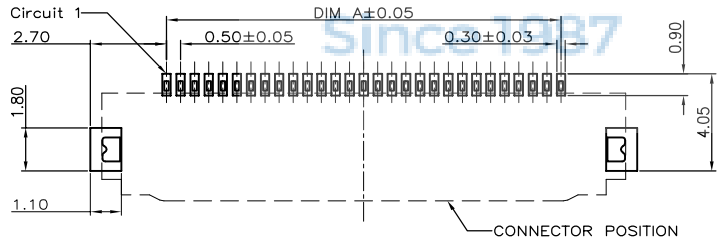

RECOMMENDED P.C.B PATTERN LAYOUT

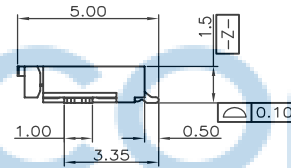
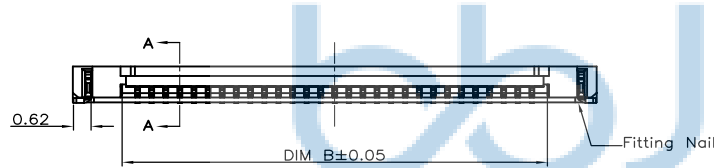
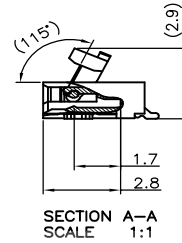
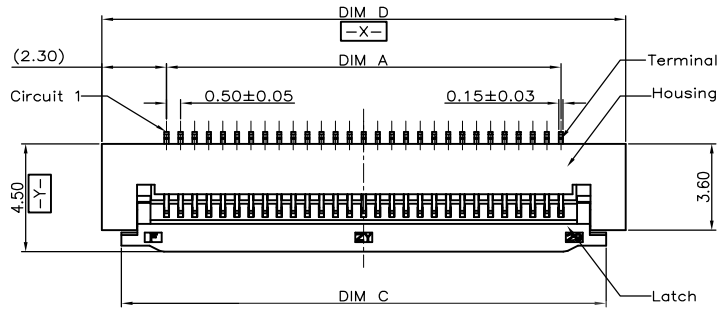
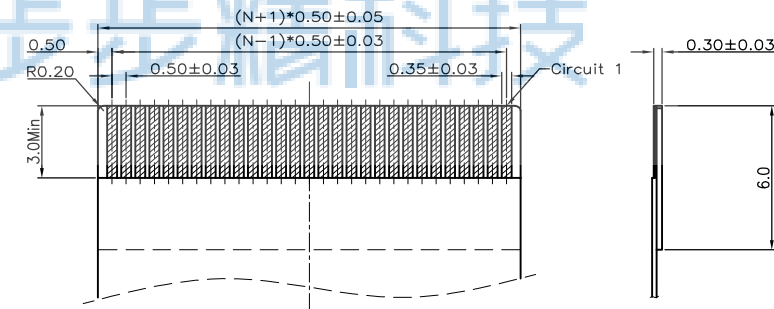

RECOMMENDED FPC/FPC DIMENSION

CKTS	DIM A	DIM B	DIM C	DIM D
4	1.50	2.60	4.70	6.10
5	2.00	3.10	5.20	6.60
6	2.50	3.60	5.70	7.10
7	3.00	4.10	6.20	7.60
8	3.50	4.60	6.70	8.10
9	4.00	5.10	7.20	8.60
10	4.50	5.60	7.70	9.10
11	5.00	6.10	8.20	9.60
12	5.50	6.60	8.70	10.10
13	6.00	7.10	9.20	10.60
14	6.50	7.60	9.70	11.10
15	7.00	8.10	10.20	11.60
16	7.50	8.60	10.70	12.10
17	8.00	9.10	11.20	12.60
18	8.50	9.60	11.70	13.10
19	9.00	10.10	12.20	13.60
20	9.50	10.60	12.70	14.10
21	10.00	11.10	13.20	14.60
22	10.50	11.60	13.70	15.10
23	11.00	12.10	14.20	15.60
24	11.50	12.60	14.70	16.10
25	12.00	13.10	15.20	16.60
26	12.50	13.60	15.70	17.10
27	13.00	14.10	16.20	17.60
28	13.50	14.60	16.70	18.10
29	14.00	15.10	17.20	18.60
30	14.50	15.60	17.70	19.10
31	15.00	16.10	18.20	19.60
32	15.50	16.60	18.70	20.10
33	16.00	17.10	19.20	20.60
34	16.50	17.60	19.70	21.10
35	17.00	18.10	20.20	21.60
36	17.50	18.60	20.70	22.10
37	18.00	19.10	21.20	22.60
38	18.50	19.60	21.70	23.10
39	19.00	20.10	22.20	23.60
40	19.50	20.60	22.70	24.10
41	20.00	21.10	23.20	24.60
42	20.50	21.60	23.70	25.10
43	21.00	22.10	24.20	25.60
44	21.50	22.60	24.70	26.10
45	22.00	23.10	25.20	26.60
46	22.50	23.60	25.70	27.10
47	23.00	24.10	26.20	27.60
48	23.50	24.60	26.70	28.10
49	24.00	25.10	27.20	28.60
50	24.50	25.60	27.70	29.10
51	25.00	26.10	28.20	29.60
52	25.50	26.60	28.70	30.10
53	26.00	27.10	29.20	30.60
54	26.50	27.60	29.70	31.10
55	27.00	28.10	30.20	31.60
56	27.50	28.60	30.70	32.10
57	28.00	29.10	31.20	32.60
58	28.50	29.60	31.70	33.10
59	29.00	30.10	32.20	33.60
60	29.50	30.60	32.70	34.10



THIS DOCUMENT IS THE SOLE PROPERTY OF BBJconn Technology Co., Ltd. CORPORATION AND SHOULD NOT BE USED IN WHOLE OR IN PART WITHOUT PRIOR WRITTEN PERMISSION.		深圳市步步精科技有限公司	
PDWG.NO: 0167-1		.X: ±0.38 .XX: ±0.25 .XXX: ±0.13	X': ±3" X'': ±2" XX': ±1"
APPD. JM_Zheng	CHKD. LYX	DR. SGF	NAME: FPC 0.5-20P 翻盖下接 H=1.5 PJ. NO.: PC.02.04-22-2008 SIZE: A4 DRW NO.: FINISH: SEE NOTES MAT'L.: SEE NOTES SCALE: N/A REV.: A0 UNIT: mm PAGE: 1/2

REV.	ECN NO.	CONTENT	DATE	ENGINEER
A0				

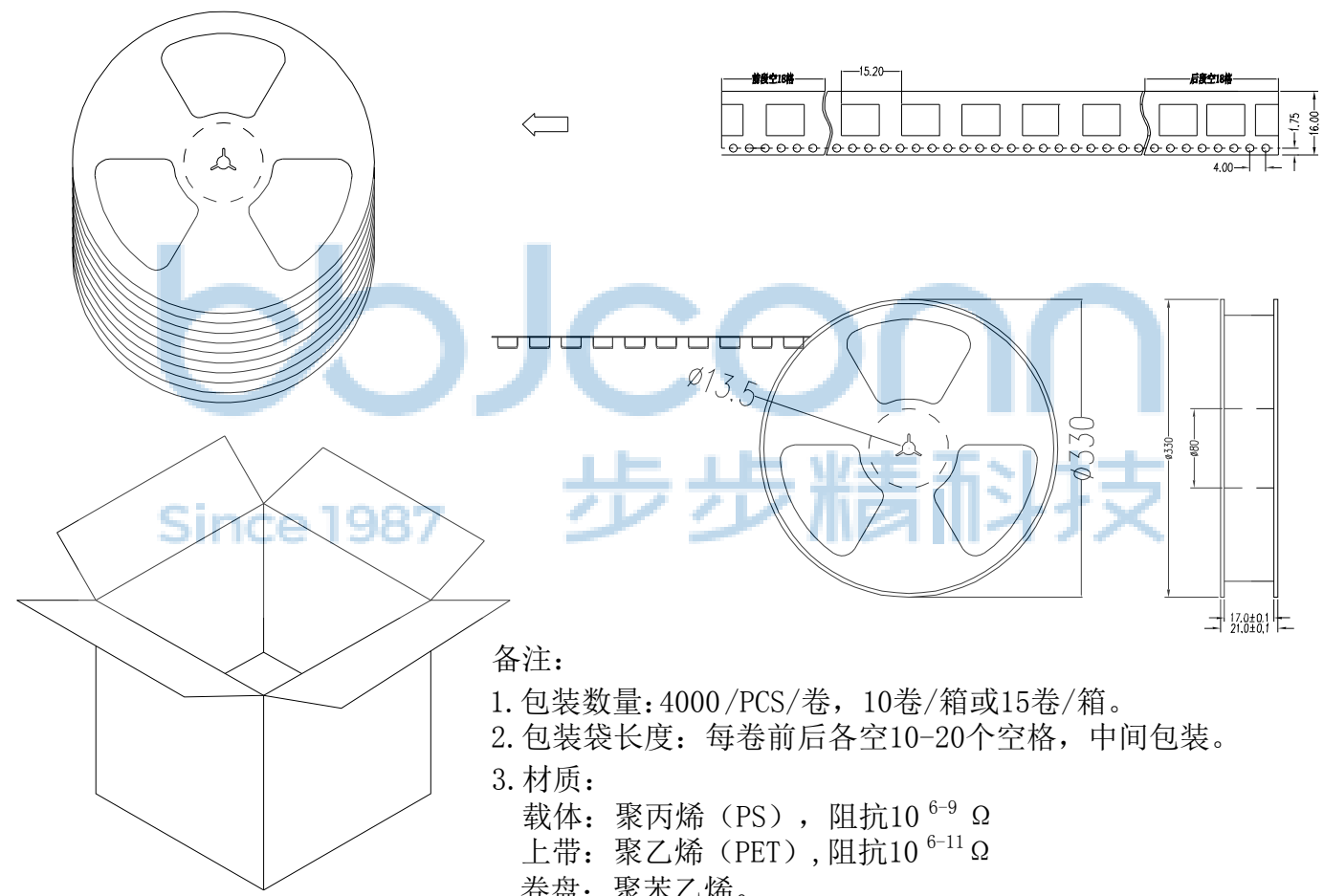

备注:

1. 包装数量: 4000 /PCS/卷, 10卷/箱或15卷/箱。
2. 包装袋长度: 每卷前后各空10-20个空格, 中间包装。
3. 材质:
载体: 聚丙烯 (PS), 阻抗 $10^{6-9} \Omega$
上带: 聚乙烯 (PET), 阻抗 $10^{6-11} \Omega$
卷盘: 聚苯乙烯。

纸箱规格: 345*345*23MM
纸箱规格: 345*345*35MM

THIS DOCUMENT IS THE SOLE PROPERTY OF BBJconn Technology Co.,Ltd. Corporation AND SHOULD NOT BE USED IN WHOLE OR IN PART WITHOUT PRIOR WRITTEN PERMISSION.		 深圳市步步精科技有限公司	
.X: ±0.38 .XX: ±0.25 .XXX: ±0.13		X': ±3" .X': ±2" .XX': ±1"	
APPD.	JM_Zheng	NAME: FPC 0.5-20P 翻盖下接 H=1.5	
CHKD.	LYX	P.J. NO.: PC.02.04-22-2008 SIZE: A4 DRW NO.:	
PDWG.NO:	0167-1	DR.	SGF
FINISH: SEE NOTES		MAT'L.: SEE NOTES	
SCALE: N/A		REV.: A0	UNIT: mm PAGE: 2/2