

REV.	ECN NO.	CONTENT	DATE	ENGINEER
A0				

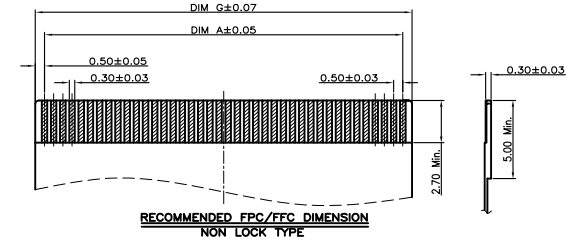
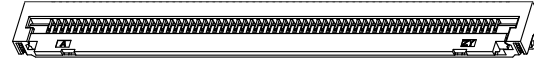
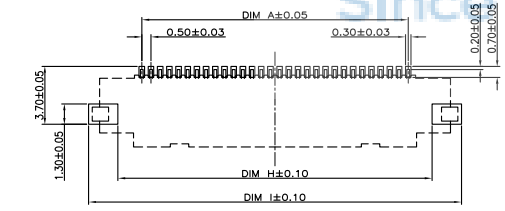
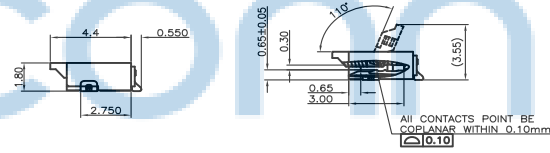
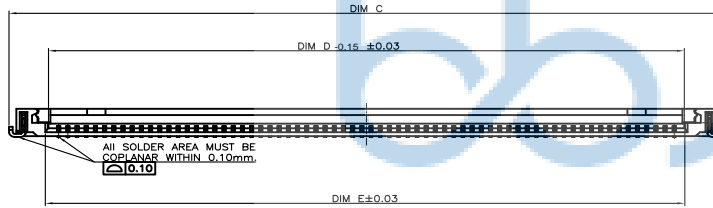
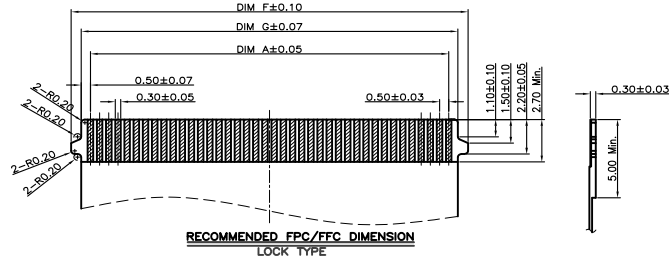
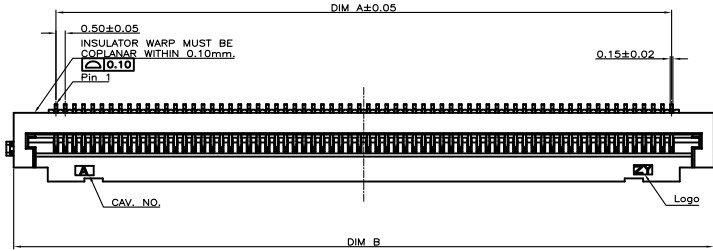

- Notes:**
- Material:**
    - Housing: thermoplastic high temp. UL94V-0; Color: Natural.
    - Actuator: thermoplastic high temp. UL94V-0; Color: black.
    - Terminal: copper alloy.
    - Hold down: copper alloy.
  - Finish:**
    - Terminal:**
      - 50u" Min. Nickel underplated overall.
      - I: Gold 3u" on Contact area and solder area
      - K: Gold 3u" on Contact area and solder area
      - L: Gold 5u" on Contact area and solder area
      - M: Gold 10u" on Contact area and solder area
    - Fitting Nail:**
      - 50u" Min. Nickel underplated overall.
      - 80~150u" Min. Matte Tin plated.

Since 1987

步步精科技



CKT	DIM A	DIM B	DIM C	DIM D	DIM E	DIM F	DIM G	DIM H	DIM I
60	29.50	34.10	34.90	30.60	30.65	31.60	30.50	32.10	35.30
80	39.50	44.10	44.90	40.60	40.65	41.60	40.50	42.10	45.30

THIS DOCUMENT IS THE SOLE PROPERTY OF BBJconn Technology Co., Ltd. Corporation AND SHOULD NOT BE USED IN WHOLE OR IN PART WITHOUT PRIOR WRITTEN PERMISSION.

PDWG.NO: 0167-1

DR. SGF

APPD. JM\_Zheng

CHKD. LYX

NAME: FPC 0.5-80P 翻盖下接 H=1.8

PJ. NO.: PC.02.04-62-2001

SIZE: A4 DRW NO.:

FINISH: SEE NOTES MAT'L.: SEE NOTES

SCALE: N/A REV.: A0 UNIT: mm PAGE: 1/2

深圳市步步精科技有限公司

.X: ±0.38 X': ±3"  
.XX: ±0.25 X'': ±2"  
.XXX: ±0.13 XXX': ±1"

REV.	ECN NO.	CONTENT	DATE	ENGINEER
A0				

- NOTES:
1. 10 SPROCKET HOLE PITCH CUMULATIVE TOLERANCE.±0.20mm
  2. CARRIER CAMBER NOT TO EXCEED 1mm IN 250mm.
  3. ALL DIMENSIONS MEET EIA-481-C REQUIREMENTS.
  4. MATERIAL: WHITE ANTI-STATIC POLYSTYRENE.
  5. THICKNESS: 0.30 ± 0.05 mm.
  6. PACKING LENGTH PER 13" REEL : 24.60METERS.
  7. COMPONENT LOAD PER 13" REEL : 2000PCS.
  8. PEELING OFF FORCE OF TOP TAPE 0.1N~0.7N(10.2gf~71.4gf).

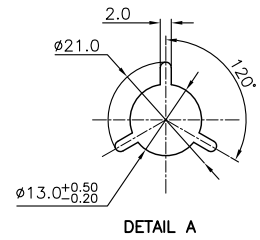
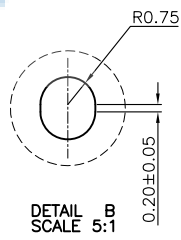
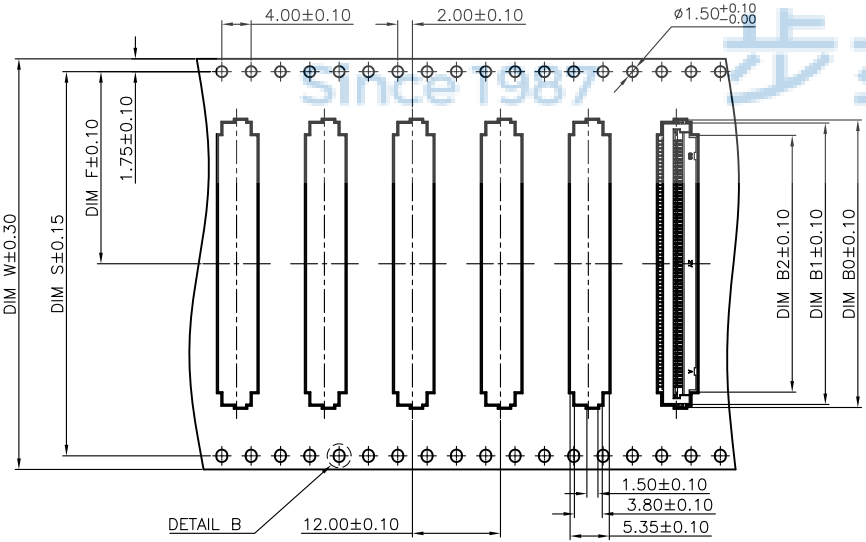
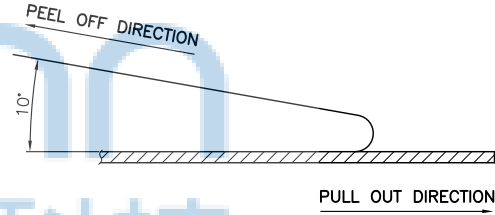
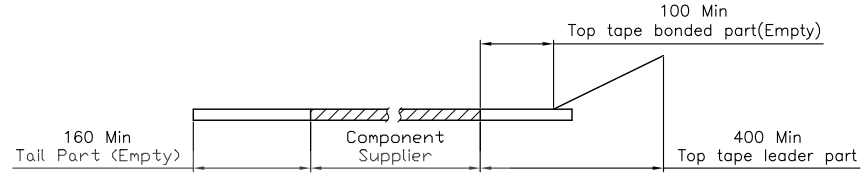
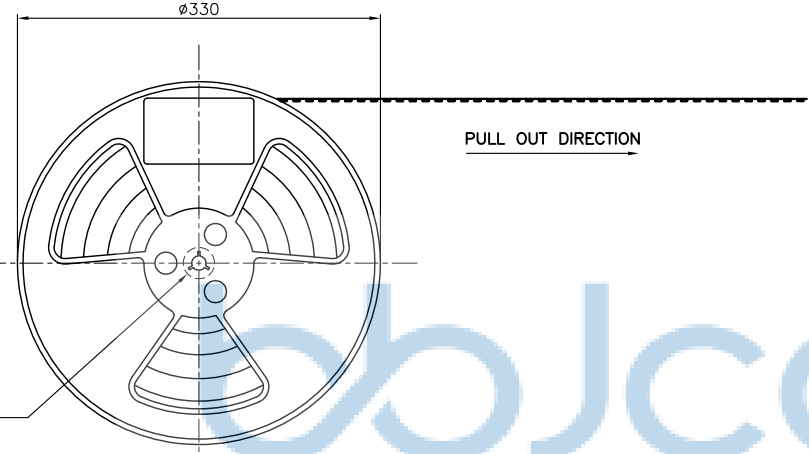
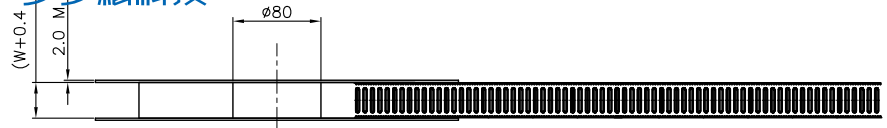

CKTS	DIM B0	DIM B1	DIM B2	DIM W	DIM S	DIM F
60	35.20	34.40	31.00	56.00	52.40	26.20
80	45.20	44.40	41.00			

THIS DOCUMENT IS THE SOLE PROPERTY OF BBJconn Technology Co.,Ltd. Corporation AND SHOULD NOT BE USED IN WHOLE OR IN PART WITHOUT PRIOR WRITTEN PERMISSION.

PDWG.NO: 0167-1

**深圳市步步精科技有限公司**

NAME: FPC 0.5-80P 翻盖下接 H=1.8

PJ. NO.: PC.02.04-62-2001

SIZE: A4 DRW NO.:

FINISH: SEE NOTES MAT'L.: SEE NOTES

SCALE: N/A REV.: A0 UNIT: mm PAGE: 2/2

APPD. JM\_Zheng

CHKD. LYX

DR. SGF

.X: ±0.38 .XX: ±0.25 .XXX: ±0.13

X': ±3" .X': ±2" .XX': ±1"