

SPECIFICATIONS:

- MECHANICAL :
 - INSERTION FORCE :44.1 N MAX
 - WITHDRAWAL FORCE :9.8 N MIN.
AFTER 5,000 CYCLES MATING: 0.5kgf MIN.
- ELECTRICAL :
 - CONTACT CURRENT RATING: 0.5A MIN.
 - VOLTAGE RATING :40V AC (rms)
 - WITHSTANDING VOLTAGE: 500 VAC FOR 1 MINUTE.
 - INSULATION RESISTANCE: 100 MEGAOHMS MIN
 - CONTACT RESISTANCE: 30 MILLIOHMS MAX.
- ENVIRONMENTAL :
 - OPERATING TEMPERATURE:-25° C TO +85° C

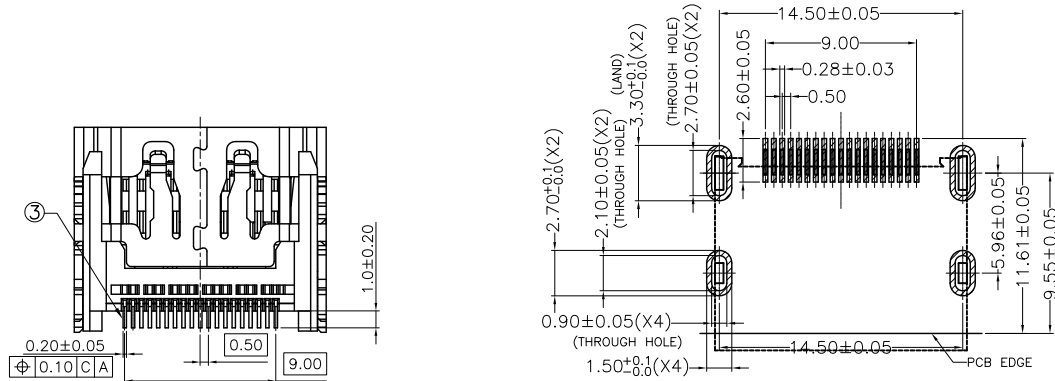

RECOMMENDED PCB LAYOUT(TOP VIEW)
(THICKNESS=1.6±0.05mm)

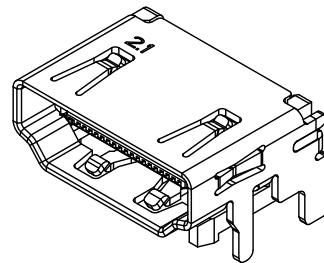
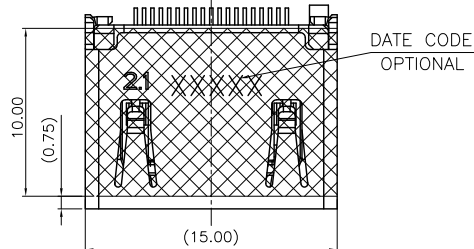
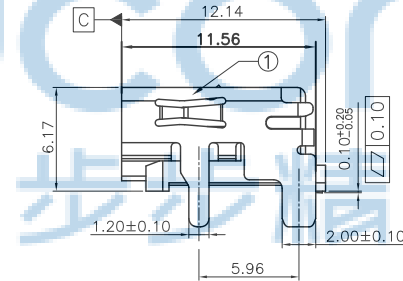
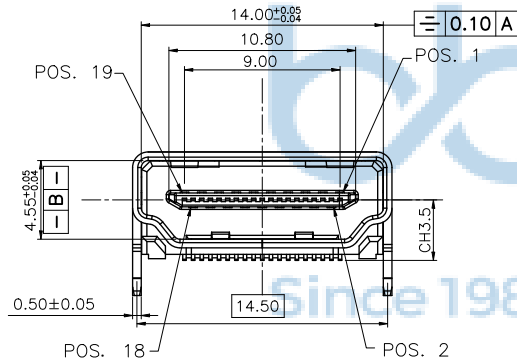

| | | | |
|-------|---------|--|------|
| 19 | CONTACT | COPPER ALLOY, GOLD FLASH PLATED ON CONTACT AREA, TIN PLATING ON SOLDER AREA, NI PLATING UNDER OVER ALL | ③ |
| 1 | HOUSING | LCP BLACK UL94V-0 | ② |
| 1 | SHELL | COPPER ALLOY/SPCC,NI PLATING OVER ALL. | ① |
| QTY'S | PART | SPFCIFICATION | ITFM |

THIS DOCUMENT IS THE SOLE PROPERTY OF BBJconn Technology Co.,Ltd. Corporation AND SHOULD NOT BE USED IN WHOLE OR IN PART WITHOUT PRIOR WRITTEN PERMISSION.

PDWG.NO: 0295-1

深圳市步步精科技有限公司

NAME: HDMI 2.1 母座 19P 板上四脚插 L=12.14 平口 LCP黑胶 铁壳 (端子SMT)

APPD. JM_Zheng

CHKD. LYX

DR. SGF

PJ. NO.: HD.01.51-14-J001

SIZE: A4 DRW NO.:

FINISH: SEE NOTES MAT'L.: SEE NOTES

SCALE: N/A REV.: A0 UNIT: mm PAGE: 1/2

| REV. | ECN NO | CONTENT | DATE | ENGINEER |
|------|--------|---------|------|----------|
| A0 | | | | |

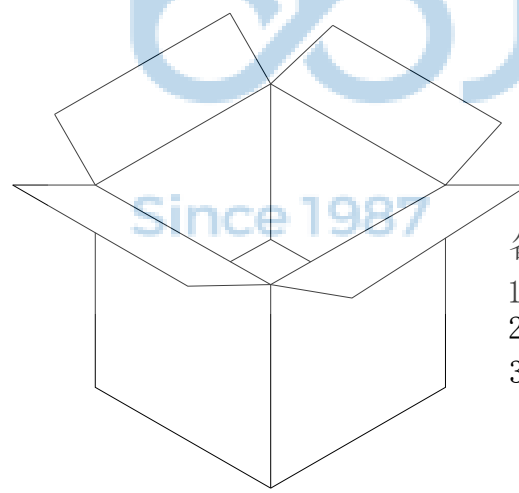
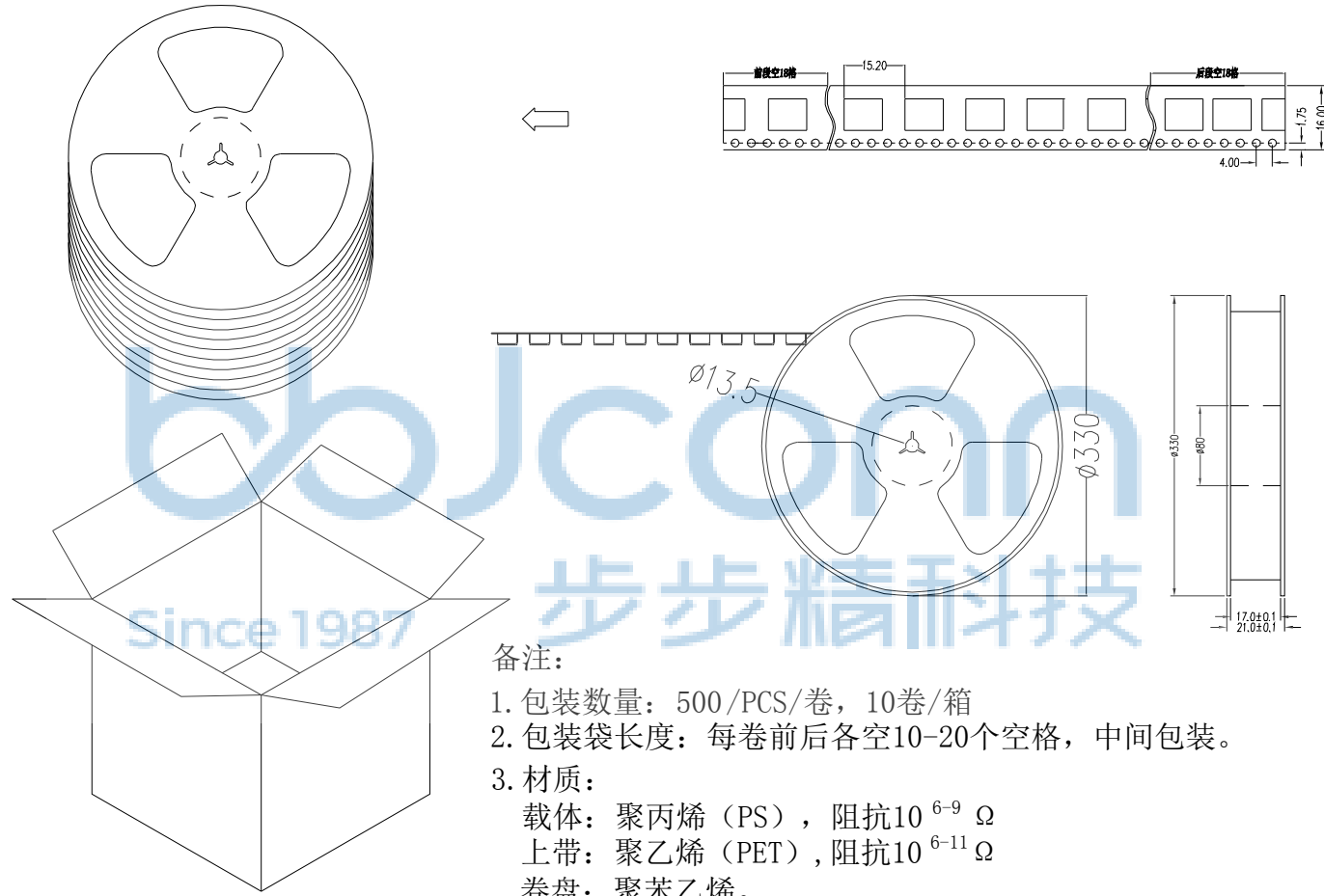

备注:

1. 包装数量: 500/PCS/卷, 10卷/箱
2. 包装袋长度: 每卷前后各空10-20个空格, 中间包装。
3. 材质:
载体: 聚丙烯 (PS), 阻抗 $10^{6-9} \Omega$
上带: 聚乙烯 (PET), 阻抗 $10^{6-11} \Omega$
卷盘: 聚苯乙烯。

纸箱规格: 345*345*23MM
纸箱规格: 345*345*35MM



| | | | | | |
|--|----------|---|-----|--|--|
| THIS DOCUMENT IS THE SOLE PROPERTY OF BBJconn Technology Co.,Ltd. Corporation AND SHOULD NOT BE USED IN WHOLE OR IN PART WITHOUT PRIOR WRITTEN PERMISSION. | | 深圳市步步精科技有限公司 .X: ±0.38 .X': ±3" .XX: ±0.25 .X'': ±2" .XXX: ±0.13 .XX': ±1" | | NAME: HDMI 2.1 母座 19P 板上四脚插 L=12.14 平口 LCP黑胶 铁壳 (端子SMT) | |
| APPD. | JM_Zheng | PJ. NO.: HD.01.51-14-J001 | | SIZE: A4 DRW NO.: | |
| CHKD. | LYX | FINISH: SEE NOTES MAT'L.: SEE NOTES | | SCALE: N/A REV.: A0 UNIT: mm PAGE: 2/2 | |
| PDWG.NO: | 0295-1 | DR. | SGF | | |