

REV.	ECN NO.	CONTENT	DATE	ENGINEER
A0		Initial release	/	TSP

**ELECTRICAL CHARACTERISTICS**

1. RATING: DC 30V 0.1A
2. CONTACT RESISTANCE: 100mΩ MAX
3. INSULATION RESISTANCE: 100MΩ MIN
4. DIELECTRIC STRENGTH: AC 250V (50~60Hz) /60S

**MECHANICAL CHARACTERISTICS**

1. PRACTICAL TEMPERATURE RANG: -40°C ~ +85°C
2. OPERATING FORCE: 180 ± 50gf
3. MECHANICAL LIFE: 20,000 cycles

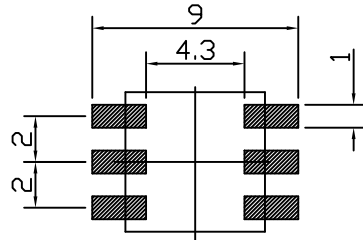
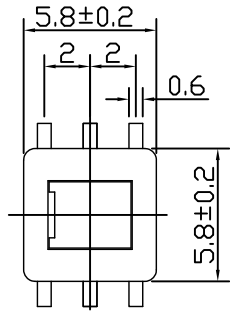

P. C. B LAYOUT

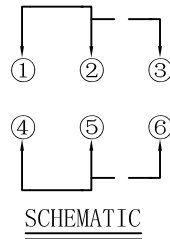
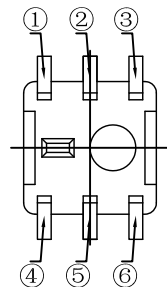
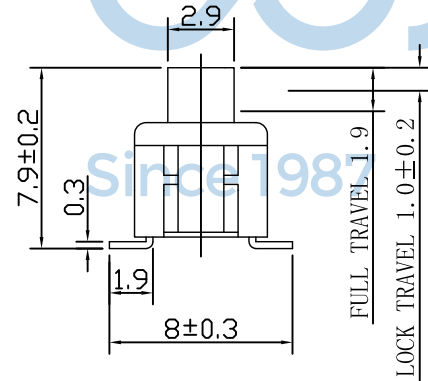
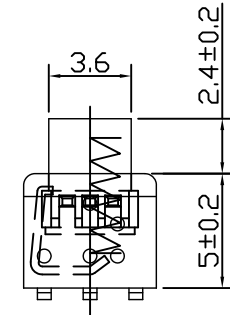
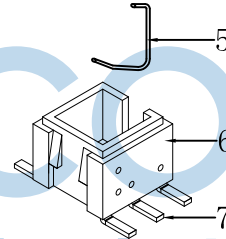
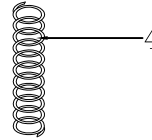
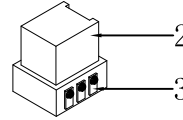
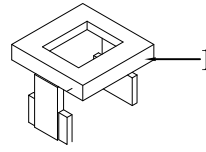

SCHEMATIC



8				
7	TERMINAL	BRASS	6	Ag PLATED
6	CASE	PPA	1	GRAY
5	LOCK PIN	SUS WIRE	1	NATURAL
4	SPRING	SUS WIRE	1	NATURAL
3	CONTACT	BRONZE	2	Ag PLATED
2	KNOB	PPA	1	WHITE
1	COVER	PPA	1	BLACK
NO.	PART NAME	MATERIAL	QTY.	FINISHING

THIS DOCUMENT IS THE SOLE PROPERTY OF BBJconn Technology Co.,Ltd. Corporation AND SHOULD NOT BE USED IN WHOLE OR IN PART WITHOUT PRIOR WRITTEN PERMISSION.

PDWG.NO: 0005-1

DR. TSP

APPD. JM\_Zheng

CHKD. LYX

NAME: 深圳市步步精科技有限公司  
按键开关 PB64L180S1.9 5.8x5.8 自锁开关 六脚贴片 平头

PJ. NO.: PS.01.02-04-2002

SIZE: A4 DRW NO.:

FINISH: SEE NOTES MAT'L.: SEE NOTES

SCALE: N/A REV.: A0 UNIT: mm PAGE: 1/2

REV.	ECN NO	CONTENT	DATE	ENGINEER
A0		Initial release	/	TSP

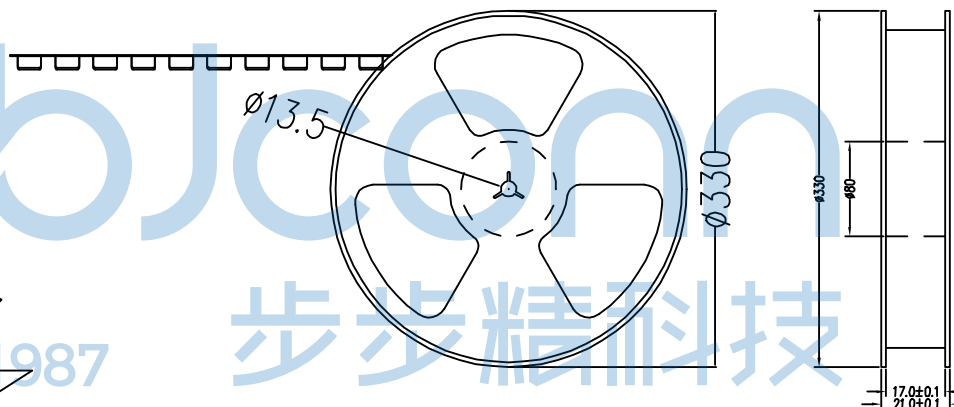
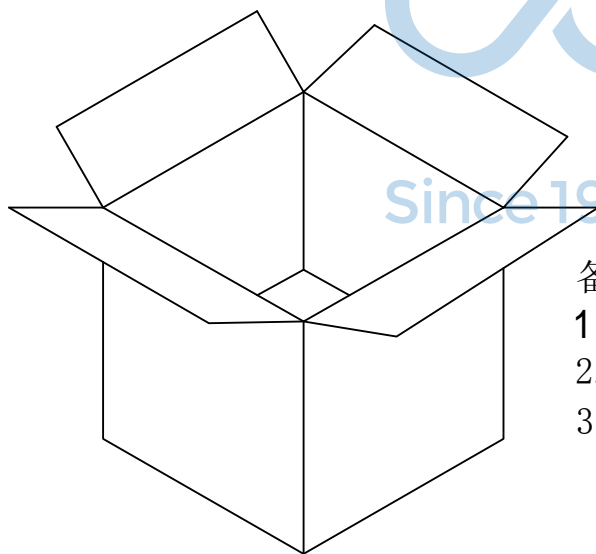
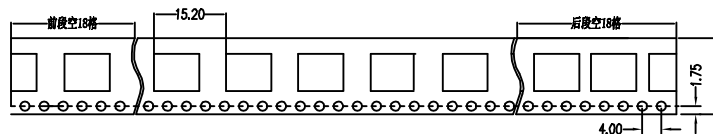
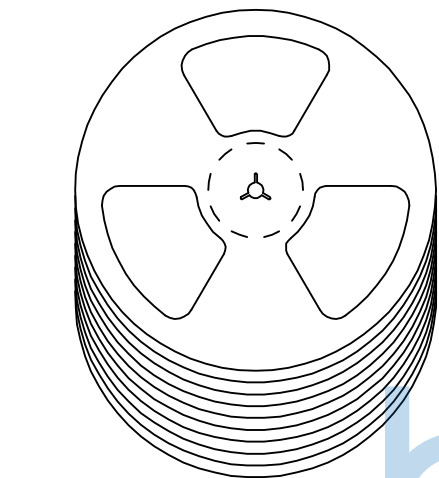

备注:

1. 包装数量：600/PCS/卷，10卷/箱
2. 包装袋长度：每卷前后各空10-20个空格，中间包装。
3. 材质：  
载体：聚丙烯（PS），  
上带：聚乙烯（PET），  
卷盘：聚苯乙烯。

纸箱规格：345\*345\*23MM

纸箱规格：345\*345\*35MM

THIS DOCUMENT IS THE SOLE PROPERTY OF BBJconn Technology Co.,Ltd. Corporation AND SHOULD NOT BE USED IN WHOLE OR IN PART WITHOUT PRIOR WRITTEN PERMISSION.		<b>深圳市步步精科技有限公司</b>	
.X: ±0.38 .XX: ±0.25 .XXX: ±0.13		X': ±3" .X': ±2" .XX': ±1"	
APPD.	JM_Zheng	NAME: 按键开关 PB64L180S1.9 5.8x5.8 自锁开关 六脚贴片 平头	
CHKD.	LYX	PJ. NO.: PS.01.02-04-2002	
DR.	TSP	SIZE: A4   DRW NO.:	
PDWG.NO:	0005-1	FINISH: SEE NOTES   MAT'L.: SEE NOTES	
		SCALE: N/A   REV.: A0   UNIT: mm   PAGE: 2/2	