

REV.	ECN NO	CONTENT	DATE	ENGINEER
A0			2023 20/04	

- CONTACT CURRENT RATING: 1A.
- CONTACT RESISTANCE: 50 mΩ MAX.;
- INSULATION RESISTANCE: 100MΩ MIN.;
- DIELECTRIC WITHSTANDING: 500V AC MIN.;
- DURABILITY: 5,000 CYCLES MIN.;
- CONNECTOR MATING FORCES: 29.4N MAX.;
- CONNECTOR UNMATING FORCES: 2.94N MIN.;

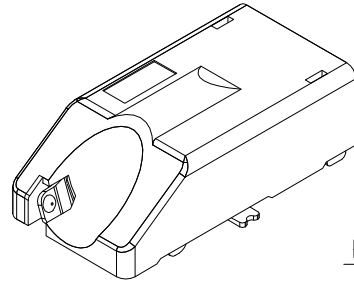

3D VIEW

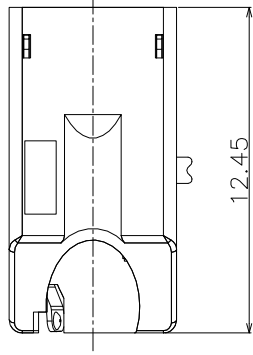
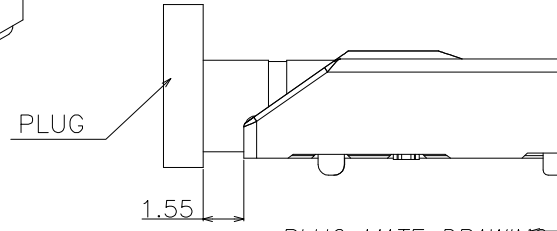

PLUG MATE DRAWING

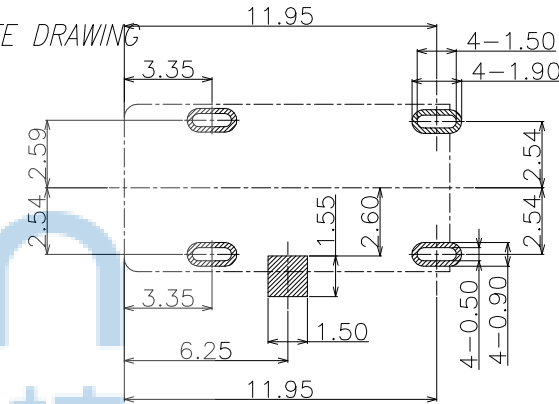
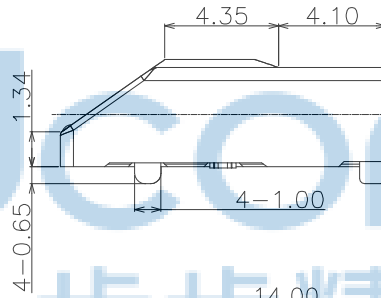
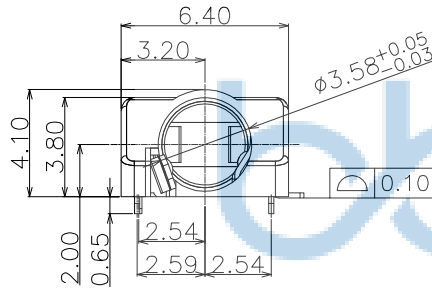

P.C.B LAYOUT
TOP VIEW

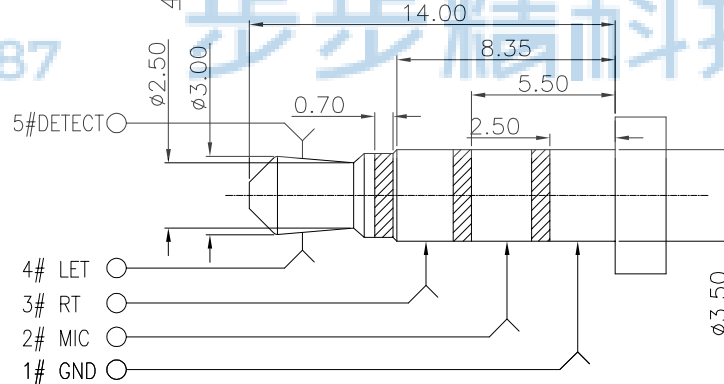
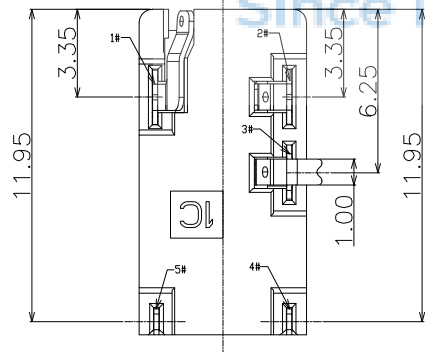

($\phi 3.50$ mm 4 POLE PLUG DETAIL DRAWING)

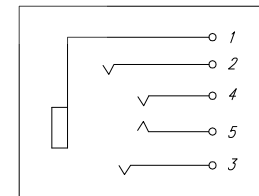

SCHEMATIC

5	DETECT
4	LET
3	RT
2	MIC
1	GND



ITEM	NAME	Q'TY	DESCRIPTION	NOTE
6	TERMINAL 5#	1	STAINLESS STEEL;NICKEL UNDER PLATING OVERALL,GOLD PLATING ON SOLDER AREA;GOLD PLATING ON CONTACT AREA	T=0.20
5	TERMINAL 4#	1		T=0.20
4	TERMINAL 3#	1		T=0.20
3	TERMINAL 2#	1	PHOSPHOR BRONZE; NICKEL UNDER PLATING OVERALL,GOLD PLATING ON SOLDER AREA ;GOLD PLATING ON CONTACT AREA	T=0.20
2	TERMINAL 1#	1		T=0.20
1	HOUSING	1	HIGHT TEMPERATURE PLASTIC COLOR BLACK	

THIS DOCUMENT IS THE
SOLE PROPERTY OF
BBJconn Technology Co.,Ltd.
Corporation AND SHOULD
NOT BE USED IN WHOLE
OR IN PART WITHOUT
PRIOR WRITTEN PERMISSION.
PDWG.NO: 0076-1

深圳市步步精科技有限公司

NAME: 3.5耳机座 斜口 四脚插一贴片 四节 (PJ35A033-F05G1ER-A)

PJ. NO.: PJ.04.22-01-3008

SIZE: A4 | DRW NO.:

FINISH: SEE NOTES | MAT'L.: SEE NOTES

SCALE: N/A | REV.: A0 | UNIT: mm | PAGE: 1/1

REV.	ECN NO.	CONTENT	DATE	ENGINEER
A0			2023 20/04	

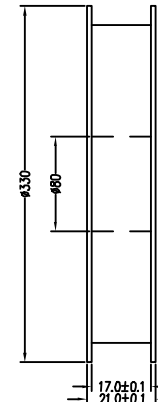
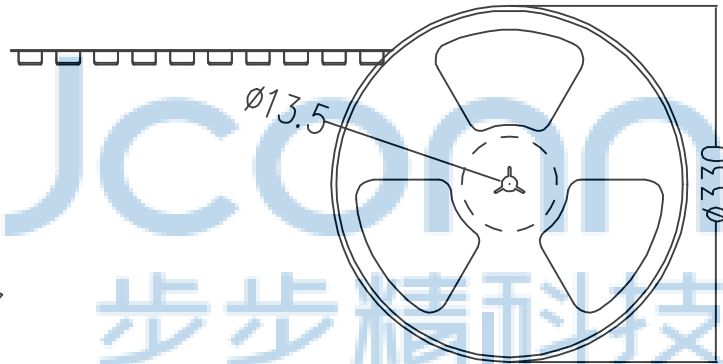
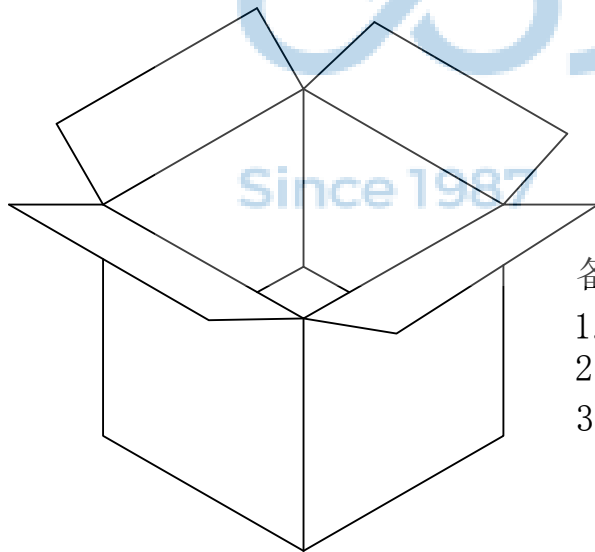
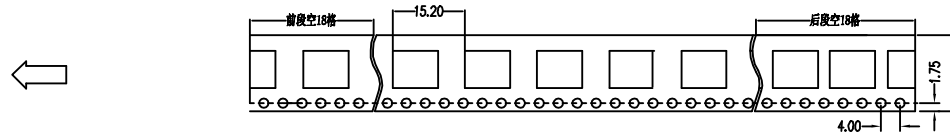
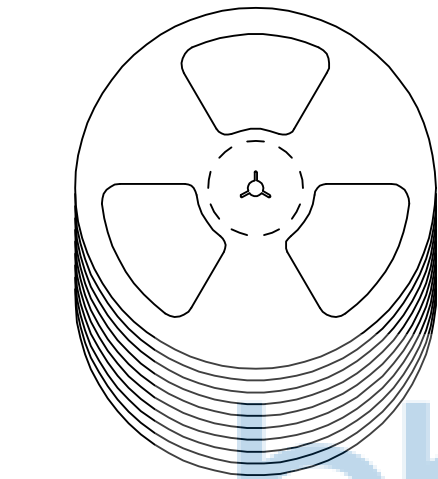

备注:

1. 包装数量: 1000/PCS/卷, 10卷/箱或15卷/箱。
2. 包装袋长度: 每卷前后各空10-20个空格, 中间包装。
3. 材质:
载体: 聚丙烯 (PS), 阻抗 $10^{6-9} \Omega$
上带: 聚乙烯 (PET), 阻抗 $10^{6-11} \Omega$
卷盘: 聚苯乙烯。

纸箱规格: 345*345*23MM

纸箱规格: 345*345*35MM

THIS DOCUMENT IS THE SOLE PROPERTY OF BBJconn Technology Co.,Ltd. Corporation AND SHOULD NOT BE USED IN WHOLE OR IN PART WITHOUT PRIOR WRITTEN PERMISSION.		PDWG.NO: 0076-1		深圳市步步精科技有限公司 .X: ±0.38 .X': ±3" .XX: ±0.25 .X": ±2" .XXX: ±0.13 .XX': ±1"		NAME: 3.5耳机座 斜口 四脚插一贴片 四节 (PJ35A033-F05G1ER-A) PJ. NO.: PJ.04.22-01-3008 SIZE: A4 DRW NO.: FINISH: SEE NOTES MAT'L.: SEE NOTES SCALE: N/A REV.: A0 UNIT: mm PAGE: 1/1	
APPD.	JM_Zheng	23/05'02					
CHKD.	LYX	23/05'02					
DR.	SGF	23/05'02					