

REV.	ECN NO	CONTENT	DATE	ENGINEER
A0				

**Note:**

- Material:
  - Housing: thermoplastic high temp.UL94V-0; Color: natural.
  - Latch: thermoplastic high temp.UL94V-0; Color: black.
  - Terminal: copper alloy.
  - Fitting Nail: copper alloy.
- Finish:
  - Terminal:  
Underplating: Au/matt Tin overall.
  - Fitting Nail:  
Underplating: matt Tin overall.
- Product must comply HF RoHS specification.

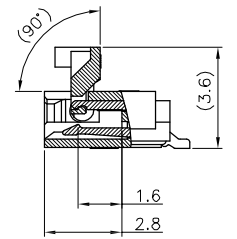
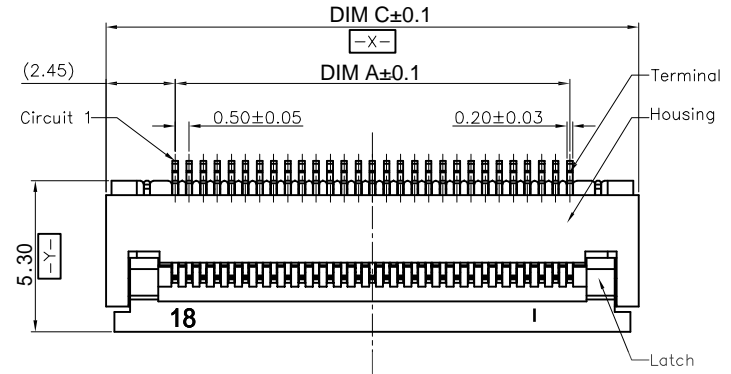

SECTION A-A  
SCALE 1:1

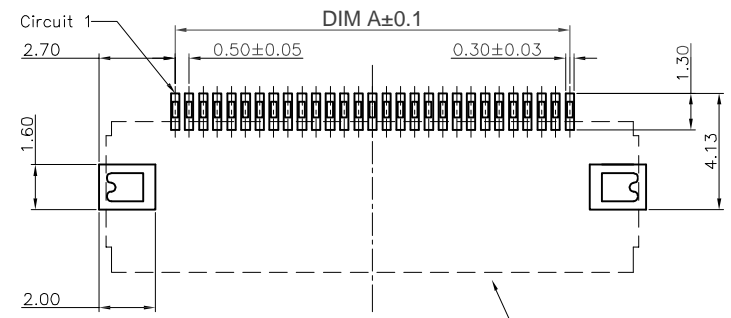
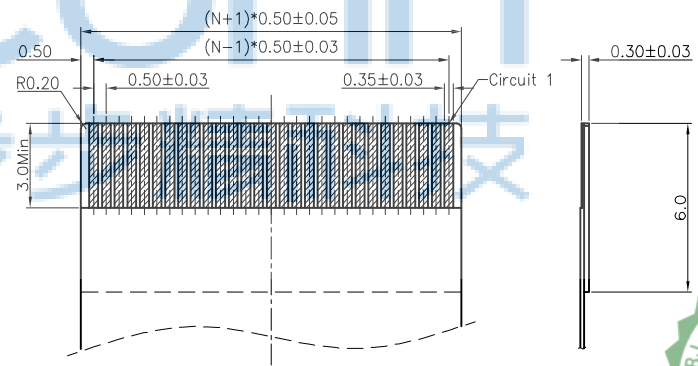
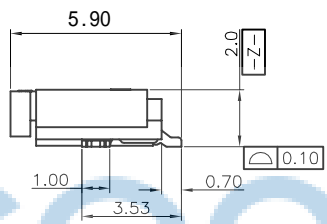
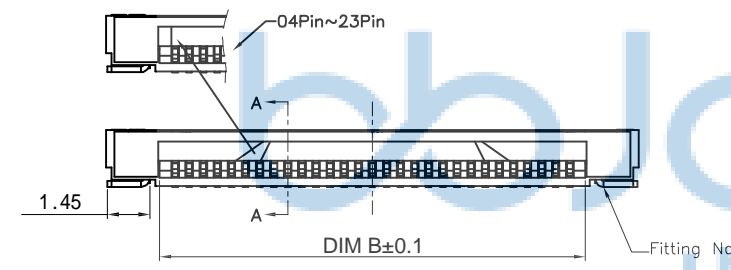

RECOMMENDED P.C.B PATTERN LAYOUT

CKTS	DIM A	DIM B	DIM C
4	1.50	2.60	6.40
5	2.00	3.10	6.90
6	2.50	3.60	7.40
7	3.00	4.10	7.90
8	3.50	4.60	8.40
9	4.00	5.10	8.90
10	4.50	5.60	9.40
11	5.00	6.10	9.90
12	5.50	6.60	10.40
13	6.00	7.10	10.90
14	6.50	7.60	11.40
15	7.00	8.10	11.90
16	7.50	8.60	12.40
17	8.00	9.10	12.90
18	8.50	9.60	13.40
19	9.00	10.10	13.90
20	9.50	10.60	14.40
21	10.00	11.10	14.90
22	10.50	11.60	15.40
23	11.00	12.10	15.90
24	11.50	12.60	16.40
25	12.00	13.10	16.90
26	12.50	13.60	17.40
27	13.00	14.10	17.90
28	13.50	14.60	18.40
29	14.00	15.10	18.90
30	14.50	15.60	19.40
31	15.00	16.10	19.90
32	15.50	16.60	20.40
33	16.00	17.10	20.90
34	16.50	17.60	21.40
35	17.00	18.10	21.90
36	17.50	18.60	22.40
37	18.00	19.10	22.90
38	18.50	19.60	23.40
39	19.00	20.10	23.90
40	19.50	20.60	24.40
41	20.00	21.10	24.90
42	20.50	21.60	25.40
43	21.00	22.10	25.90
44	21.50	22.60	26.40
45	22.00	23.10	26.90
46	22.50	23.60	27.40
47	23.00	24.10	27.90
48	23.50	24.60	28.40
49	24.00	25.10	28.90
50	24.50	25.60	29.40
51	25.00	26.10	29.90
52	25.50	26.60	30.40
53	26.00	27.10	30.90
54	26.50	27.60	31.40
55	27.00	28.10	31.90
56	27.50	28.60	32.40
57	28.00	29.10	32.90
58	28.50	29.60	33.40
59	29.00	30.10	33.90
60	29.50	30.60	34.40



THIS DOCUMENT IS THE SOLE PROPERTY OF **BBJconn Technology Co.,Ltd.** 深圳市步步精科技有限公司

Corporation AND SHOULD NOT BE USED IN WHOLE OR IN PART WITHOUT PRIOR WRITTEN PERMISSION.

PDWG.NO: 0407-1

NAME: 0.5-8P翻盖下接H =2.0mm

PJ. NO.: PC.02.04-32-C002

SIZE: A4 DRW NO.:

FINISH: SEE NOTES MAT'L.: SEE NOTES

SCALE: N/A REV.: A0 UNIT: mm PAGE: 1/2

APPD. JM\_Zheng

CHKD. LYX

DR. SGF

REV.	ECN NO	CONTENT	DATE	ENGINEER
A0				

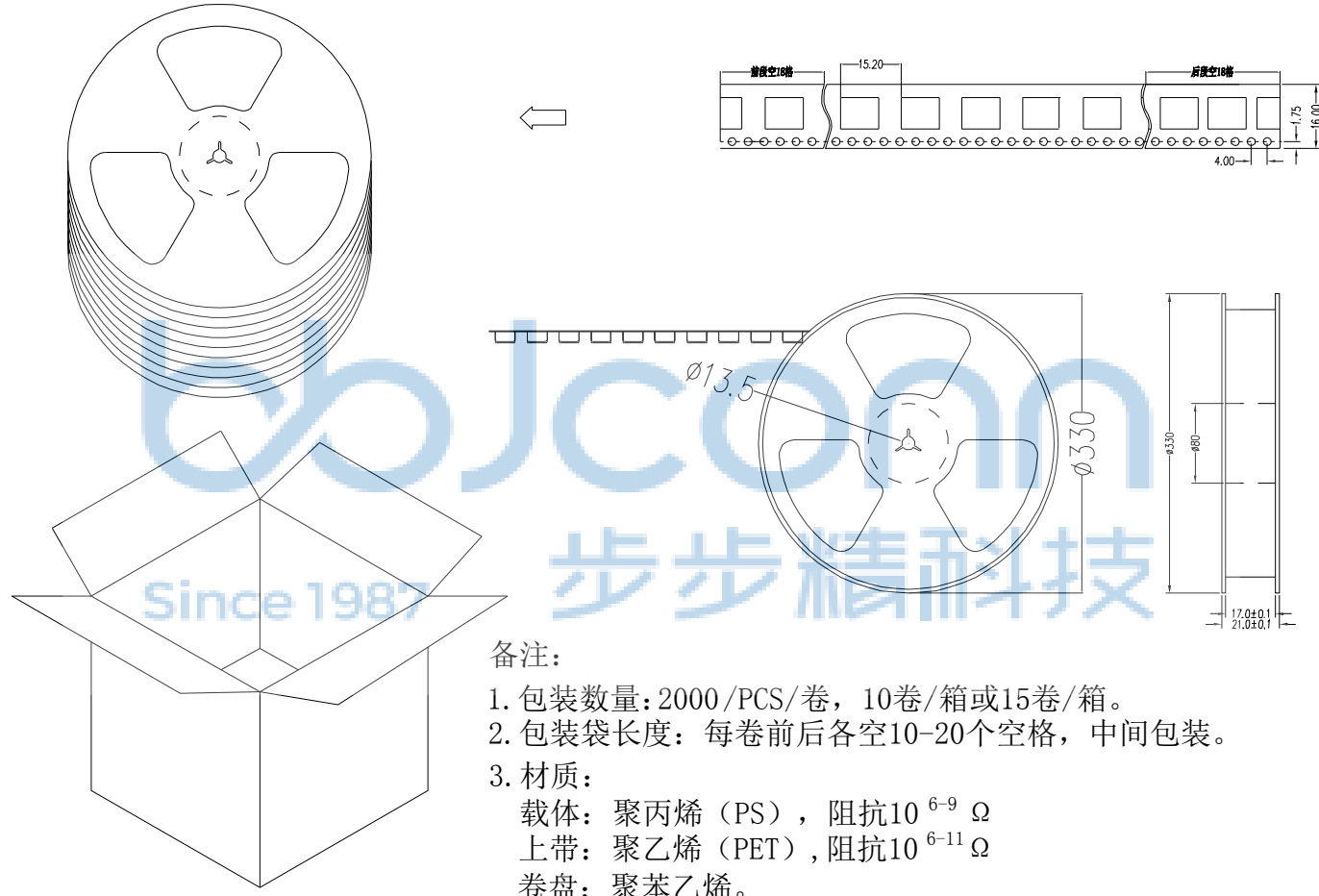

备注：  
 1. 包装数量：2000/PCS/卷，10卷/箱或15卷/箱。  
 2. 包装袋长度：每卷前后各空10-20个空格，中间包装。  
 3. 材质：  
 载体：聚丙烯（PS），阻抗 $10^{6-9} \Omega$   
 上带：聚乙烯（PET），阻抗 $10^{6-11} \Omega$   
 卷盘：聚苯乙烯。  
 纸箱规格：345\*345\*23MM  
 纸箱规格：345\*345\*35MM

THIS DOCUMENT IS THE SOLE PROPERTY OF BBJconn Technology Co.,Ltd. Corporation AND SHOULD NOT BE USED IN WHOLE OR IN PART WITHOUT PRIOR WRITTEN PERMISSION.		<b>深圳市步步精科技有限公司</b>	
.X: $\pm 0.38$ .XX: $\pm 0.25$ .XXX: $\pm 0.13$		NAME: 0.5-8P翻盖下接H =2.0mm P.J. NO.: PC.02.04-32-C002 SIZE: A4   DRW NO.: FINISH: SEE NOTES   MAT'L.: SEE NOTES SCALE: N/A   REV.: A0   UNIT: mm   PAGE: 2/2	
APPD.	JM_Zheng		
CHKD.	LYX		
PDWG.NO:	0407-1	DR.	SGF