

REV.	ECN NO	CONTENT	DATE	ENGINEER
AO				

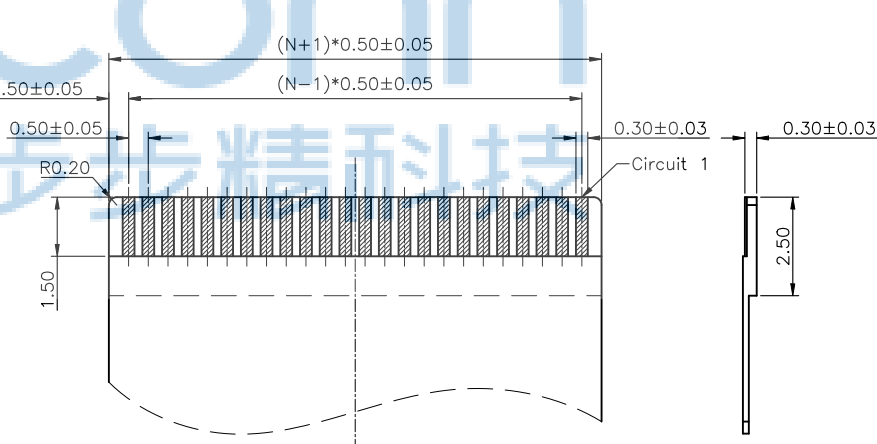

- Note:**
- Material:**
    - Housing: LCP .UL94V-0; Color: black.
    - Latch: PA9T .UL94V-0; Color: black.
    - Terminal: Phosphor bronze.
    - Fitting Nail: Phosphor bronze.
  - Finish:**
    - Terminal:**
      - 40~100u" Nickel under plating over all
      - 1:1u" Gold on contact and Gold Flash on Solder
      - 2:2u" Gold on contact and Gold Flash on Solder
      - 3:3u" Gold on contact and Gold Flash on Solder
      - 4:5u" Gold on contact and Gold Flash on Solder
      - 5:5u" Gold on contact and Gold Flash on Solder
      - K:3u" Gold on contact and Gold Flash on Solder
      - L:4u" Gold on contact and Gold Flash on Solder
      - M:5u" Gold on contact and Gold Flash on Solder
    - Fitting Nail:**
      - 40~100u" Nickel under plating over all
      - 80~120u" Matte tin over all
  - Product must comply HF RoHS specification.**

CKTS	DIM A	DIM B	DIM C	DIM D	DIM E	DIM F
4	1.50	3.38	2.53	4.00	3.10	3.90
5	2.00	3.88	3.03	4.50	3.60	4.40
6	2.50	4.38	3.53	5.00	4.10	4.90
7	3.00	4.88	4.03	5.50	4.60	5.40
8	3.50	5.38	4.53	6.00	5.10	5.90
9	4.00	5.88	5.03	6.50	5.60	6.40
10	4.50	6.38	5.53	7.00	6.10	6.90
11	5.00	6.88	6.03	7.50	6.60	7.40
12	5.50	7.38	6.53	8.00	7.10	7.90
13	6.00	7.88	7.03	8.50	7.60	8.40
14	6.50	8.38	7.53	9.00	8.10	8.90
15	7.00	8.88	8.03	9.50	8.60	9.40
16	7.50	9.38	8.53	10.00	9.10	9.90
17	8.00	9.88	9.03	10.50	9.60	10.40
18	8.50	10.38	9.53	11.00	10.10	10.90
19	9.00	10.88	10.03	11.50	10.60	11.40
20	9.50	11.38	10.53	12.00	11.10	11.90
21	10.00	11.88	11.03	12.50	11.60	12.40
22	10.50	12.38	11.53	13.00	12.10	12.90
23	11.00	12.88	12.03	13.50	12.60	13.40
24	11.50	13.38	12.53	14.00	13.10	13.90
25	12.00	13.88	13.03	14.50	13.60	14.40
26	12.50	14.38	13.53	15.00	14.10	14.90
27	13.00	14.88	14.03	15.50	14.60	15.40
28	13.50	15.38	14.53	16.00	15.10	15.90
29	14.00	15.88	15.03	16.50	15.60	16.40
30	14.50	16.38	15.53	17.00	16.10	16.90
31	15.00	16.88	16.03	17.50	16.60	17.40
32	15.50	17.38	16.53	18.00	17.10	17.90
33	16.00	17.88	17.03	18.50	17.60	18.40
34	16.50	18.38	17.53	19.00	18.10	18.90
35	17.00	18.88	18.03	19.50	18.60	19.40
36	17.50	19.38	18.53	20.00	19.10	19.90
37	18.00	19.88	19.03	20.50	19.60	20.40
38	18.50	20.38	19.53	21.00	20.10	20.90
39	19.00	20.88	20.03	21.50	20.60	21.40
40	19.50	21.38	20.53	22.00	21.10	21.90
41	20.00	21.88	21.03	22.50	21.60	22.40
42	20.50	22.38	21.53	23.00	22.10	22.90
43	21.00	22.88	22.03	23.50	22.60	23.40
44	21.50	23.38	22.53	24.00	23.10	23.90
45	22.00	23.88	23.03	24.50	23.60	24.40
46	22.50	24.38	23.53	25.00	24.10	24.90
47	23.00	24.88	24.03	25.50	24.60	25.40
48	23.50	25.38	24.53	26.00	25.10	25.90
49	24.00	25.88	25.03	26.50	25.60	26.40
50	24.50	26.38	25.53	27.00	26.10	26.90

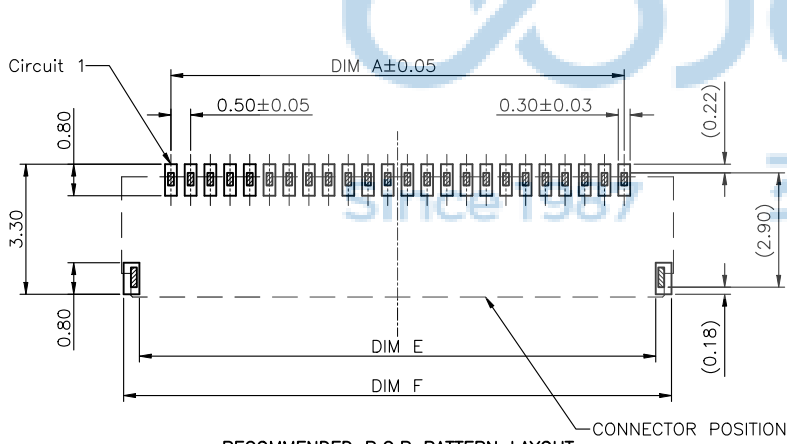
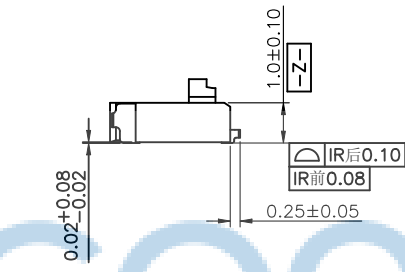
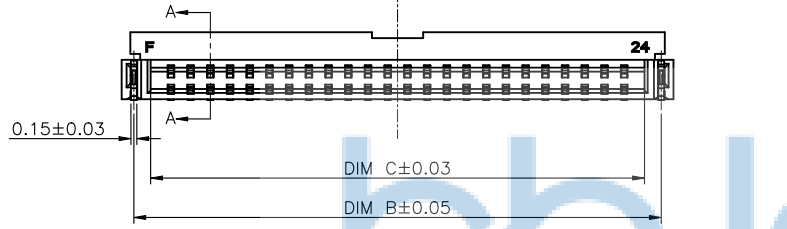
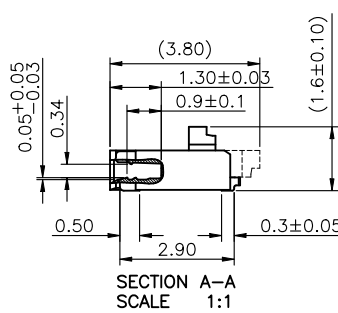
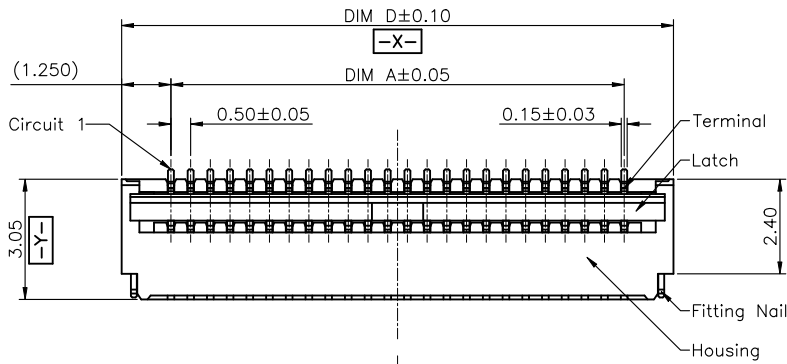

THIS DOCUMENT IS THE SOLE PROPERTY OF BBJconn Technology Co., Ltd. Corporation AND SHOULD NOT BE USED IN WHOLE OR IN PART WITHOUT PRIOR WRITTEN PERMISSION.

PDWG.NO: 0167-1

APPD. JM\_Zheng

CHKD. LYX

DR. TSP

NAME: FPC 0.5-20P 后翻式 H=1.0 (AFC42)

PJ. NO.: PC.02.05-12-2001

SIZE: A4 DRW NO.:

FINISH: SEE NOTES MAT'L.: SEE NOTES

SCALE: N/A REV.: AO UNIT: mm PAGE: 1/2

REV.	ECN NO	CONTENT	DATE	ENGINEER
A0				

**NOTES:**

1. 10 SPROCKET HOLE PITCH CUMULATIVE TOLERANCE.±0.20mm
2. CARRIER CAMBER NOT TO EXCEED 1mm IN 250mm.
3. ALL DIMENSIONS MEET EIA-481-C REQUIREMENTS.
4. MATERIAL: BLACK ANTI-STATIC POLYSTYRENE.
5. THICKNESS: 0.35 ± 0.05 mm.
6. PACKING LENGTH PER 13" REEL : 32.40METERS.
7. COMPONENT LOAD PER 13" REEL : 4000PCS.
8. PEELING OFF FORCE OF TOP TAPE 0.1N~0.7N(10.2gf~71.4gf).

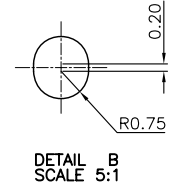
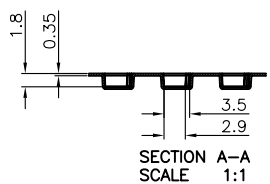
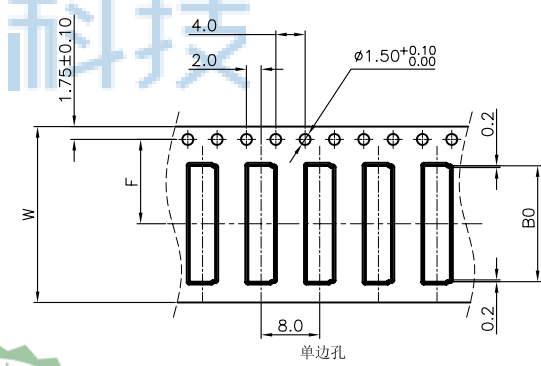
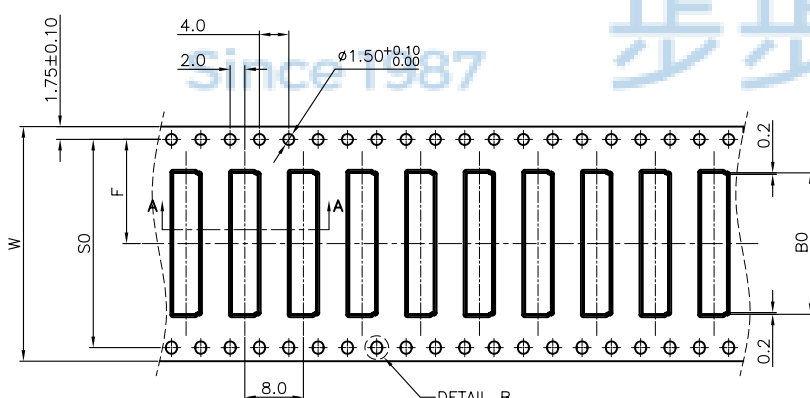
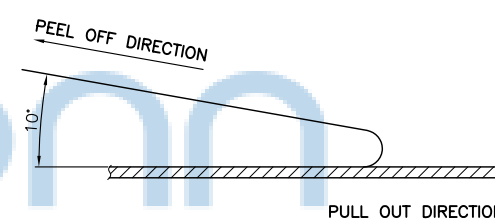
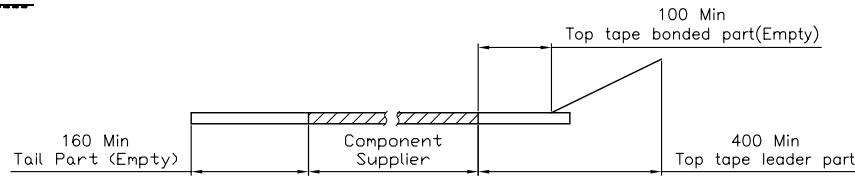
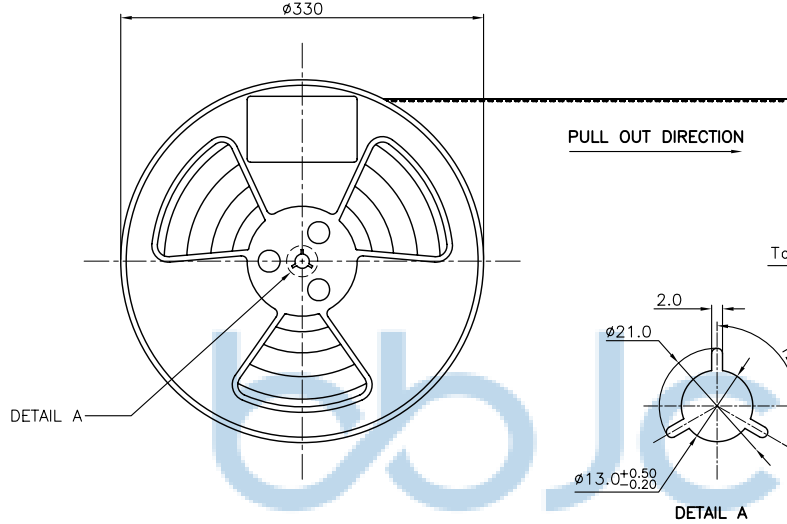
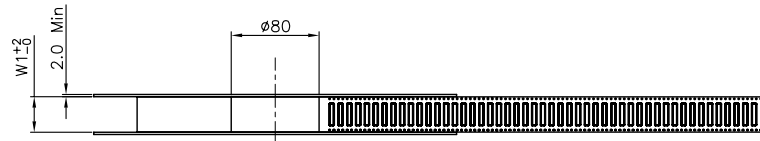

CKTS	B0±0.10	W	W1	F±0.10	S0±0.10
4	4.30				
5	4.80				
6	5.30				
7	5.80	16+0.3/-0	16.4	7.5	
8	6.30				
9	6.80				
10	7.30				
11	7.80				
12	8.30				
13	8.80				
14	9.30				
15	9.80				
16	10.30				
17	10.80				
18	11.30				
19	11.80	24+0.3/-0	24.4	11.5	
20	12.30				
21	12.80				
22	13.30				
23	13.80				
24	14.30				
25	14.80				
26	15.30				
27	15.80				
28	16.30				
29	16.80				
30	17.30				
31	17.80				
32	18.30				
33	18.80	32±0.30	32.4	14.2	28.4
34	19.30				
35	19.80				
36	20.30				
37	20.80				
38	21.30				
39	21.80				
40	22.30				
41	22.80				
42	23.30				
43	23.80				
44	24.30				
45	24.80	44±0.35	44.4	20.2	40.4
46	25.30				
47	25.80				
48	26.30				
49	26.80				
50	27.30				

THIS DOCUMENT IS THE SOLE PROPERTY OF BBJconn Technology Co.,Ltd. Corporation AND SHOULD NOT BE USED IN WHOLE OR IN PART WITHOUT PRIOR WRITTEN PERMISSION.

PDWG.NO: 0167-1

APPD. JM\_Zheng  
CHKD. LYX  
DR. TSP

NAME: FPC 0.5-20P 后翻式 H=1.0 (AFC42)

PJ. NO.: PC.02.05-12-2001  
SIZE: A4 | DRW NO.:  
FINISH: SEE NOTES | MAT'L.: SEE NOTES  
SCALE: N/A | REV.: A0 | UNIT: mm | PAGE: 2/2

深圳市步步精科技有限公司