

REV.	ECN NO	CONTENT	DATE	ENGINEER
AO				

NOTES:

- ELECTRICAL CHARACTERISTICS
 - CONTACT RESISTANCE: 60 Milliohms Max
 - INSULATION RESISTANCE: 1,000 Megohms Min.
 - DIELECTRIC WITHSTANDING VOLTAGE: 500V AC FOR 1 MINUTE.
- MECHANICAL CHARACTERISTICS
 - OPERATION TEMPERATURE RANGE: -25° C~+70° C
 - DURABILITY: 5000 CYCLES
- MATERIAL:
 - HOUSING: THERMOPLASTIC, UL 94-V0
 - TERMINAL: PHOSPHOR BRONZE, T=0.15
 - SHELL: STAINLESS STEEL, T=0.15
- FINISHED:
 - TERMINAL: Ni PLATED UNDER, Au PLATED ON CONTACT AREA, G/F PLATED ON SOLDER TAIL

SIM CARD	
Pin No.	NAME
C1	VCC
C2	RST
C3	CLK
C4	RESERVED
C5	GND
C6	VPP
C7	I/O
C8	RESERVED

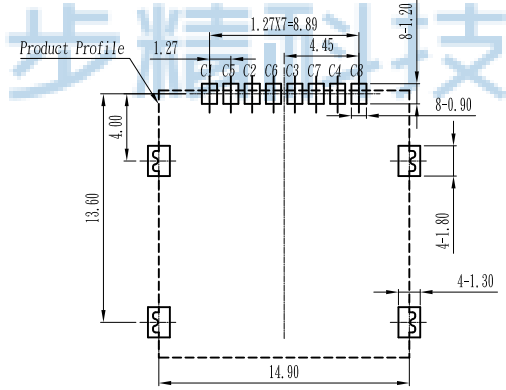
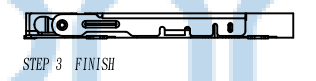
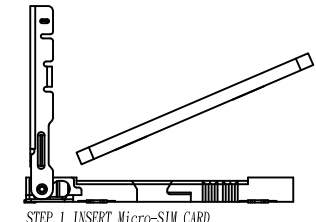
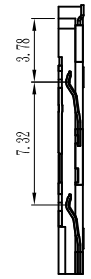
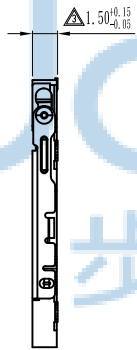
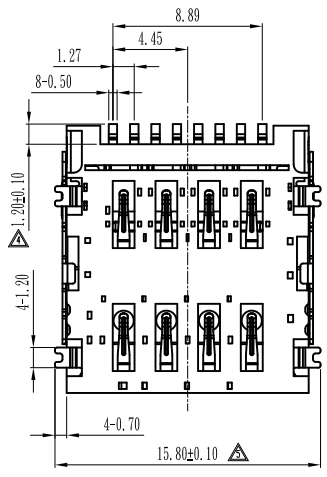
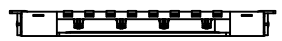
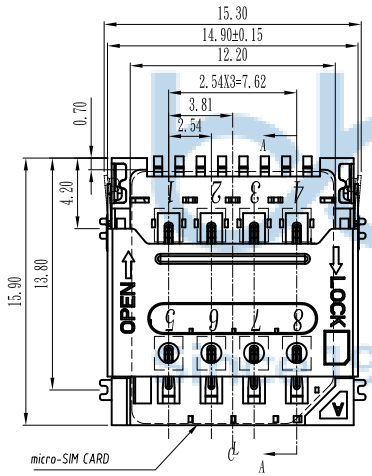
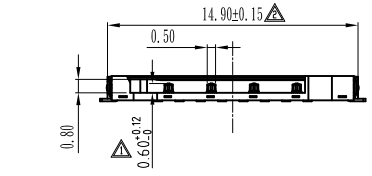

RECOMMENDED PCB LAYOUT
GENERAL TOLERANCE ±0.05

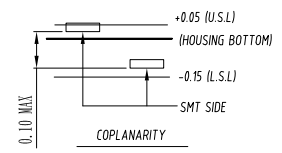

THIS DOCUMENT IS THE SOLE PROPERTY OF BBJconn Technology Co., Ltd.		深圳市步步精科技有限公司	
CORPORATION AND SHOULD NOT BE USED IN WHOLE OR IN PART WITHOUT PRIOR WRITTEN PERMISSION.		NAME: 卡座 MICRO SIM 8PIN H=1.5 贴片 掀盖式 (CS-234-08-W)	
APPD.	JM_Zheng	PJ. NO.: CD.02.02-14-0004	
CHKD.	LYX	SIZE: A4 DRW NO.:	
PDWG.NO:	0390-1	DR.	LHC
		FINISH: SEE NOTES MAT'L.: SEE NOTES	
		SCALE: N/A	REV.: AO UNIT: mm PAGE: 1/2

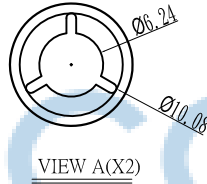
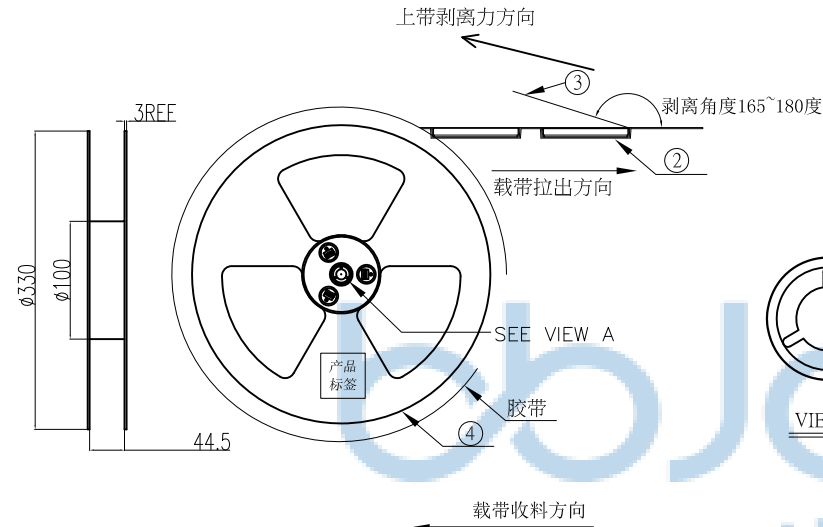

PACKING NOTES:

1. PRIMARY PACKING:1300PCS/REEL;
2. SECONDARY PACKING: 10 REELS/CARTON (13KPCS/CARTON)
3. PEELING RESISTANCE: 30gf~100gf
4. PEELING ANGLE:165°~180°
5. PEELING SPEED: 300mm/minutes.

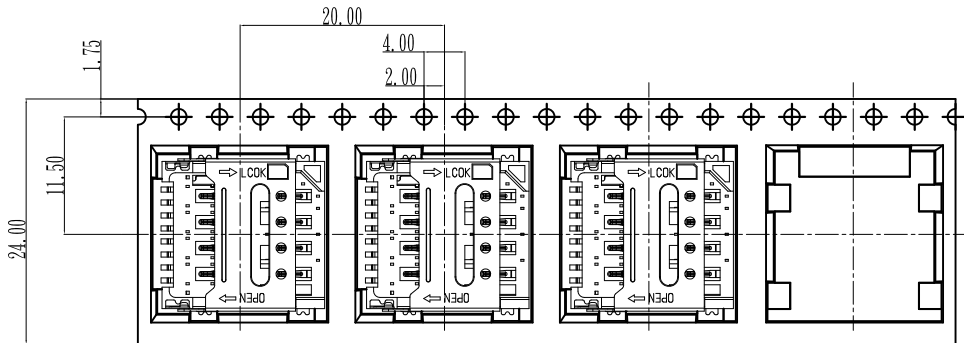
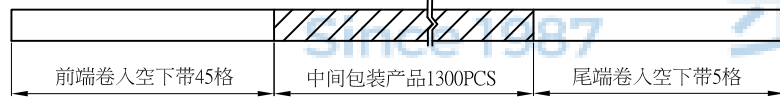
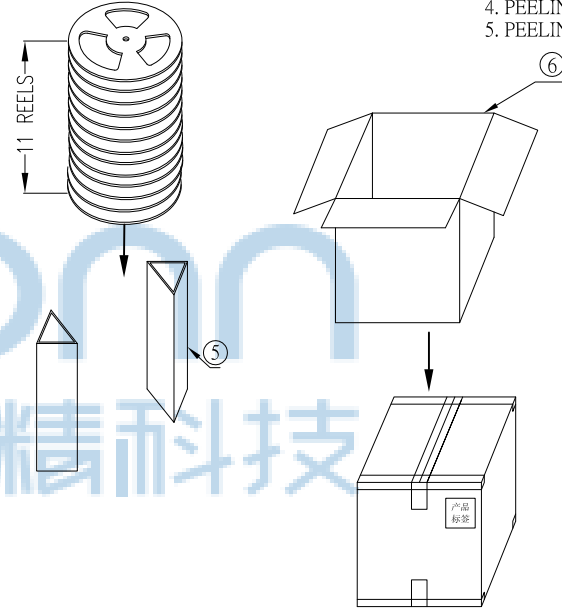

TABLE:

NO.	NAME	SPEC.	REMARK
①	成品	掀盖 MICRO SIM CARD 1.5H	1300PCS/R
②	下带(载带)	PET料 透明色,W=24mm,P=20mm,T=0.3mm,	26.6M/1300PCS
③	上带(盖带)	W=21.5mm,T=0.06mm,白粘式透明状	26.8M/1300PCS
④	REEL(蓝色卷盘)	外直径330mm,内直径100mm,内宽44.5mm	1PCS/1300PCS
⑤	折叠板	296*464*6mm	4PCS/14300PCS
⑥	CARTON (外箱)	350*350*350mm	

THIS DOCUMENT IS THE SOLE PROPERTY OF BBJconn Technology Co.,Ltd. Corporation AND SHOULD NOT BE USED IN WHOLE OR IN PART WITHOUT PRIOR WRITTEN PERMISSION. PDWG.NO: 0390-1

深圳市步步精科技有限公司

NAME: 卡座 MICRO SIM 8PIN H=1.5 贴片 掀盖式 (CS-234-08-W)

APPD. JM_Zheng

CHKD. LYX

DR. LHC

PJ. NO.: CD.02.02-14-0004

SIZE: A4 | DRW NO.:

FINISH: SEE NOTES | MAT'L.: SEE NOTES

SCALE: N/A | REV.: A0 | UNIT: mm | PAGE: 2/2