

REV.	ECN NO	CONTENT	DATE	ENGINEER
A0		Initial release	/	ZY

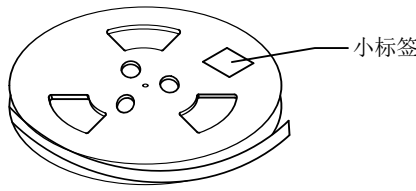

② 卷盘贴标签示意图

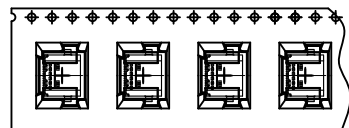
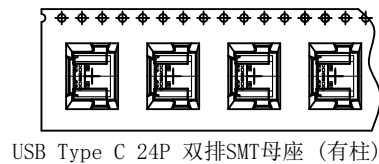
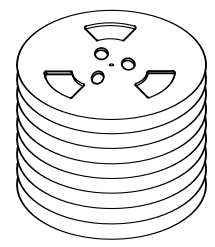

③ 10盘产品叠层示意图

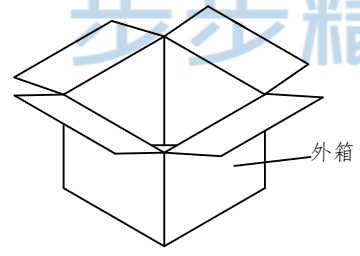

④ 产品入外箱示意图

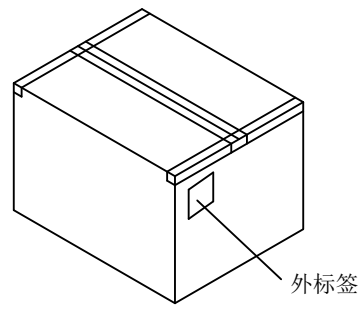

⑤ 外箱封箱示意图

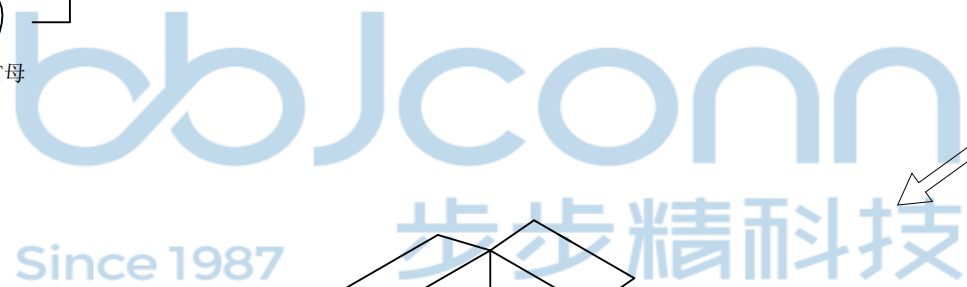

NOTE:

1. QUANTITY/REEL: 900 PCS
数量/卷: 900 PCS
QUANTITY/INNER CARTON: 900 X 10 = 9000 PCS
数量/箱: 900 X 10 = 9000 PCS
2. FREE 28 CAVE IN THE FRONT CARRIER AND FREE 28 CAVE IN THE END CARRIER.
包装带内圈空28格, 外圈空28格.

THIS DOCUMENT IS THE SOLE PROPERTY OF BBJconn Technology Co., Ltd. Corporation AND SHOULD NOT BE USED IN WHOLE OR IN PART WITHOUT PRIOR WRITTEN PERMISSION.		深圳市步步精科技有限公司 .X: ±0.38 .X': ±3" .XX: ±0.25 .X': ±2" .XXX: ±0.13 .XX': ±1"		NAME: TYPE C 24P 母座 板上型 L=7.90 CH=1.68 四脚插 带柱 端子双排SMT 编带		
APPD.	JM_Zheng	PJ. NO.: 126-221-240001-K6G SIZE: A4 DRW NO.:	FINISH: SEE NOTES MAT'L.: SEE NOTES			
CHKD.	LYX		SCALE: N/A	REV.: A0	UNIT: mm	PAGE: 2/2
PDWG.NO:	0413-1	DR.	ZY			