

RECOMMENDED P.C.B. LAYOUT
TOLERANCE UNSPECIFIED ±0.05mm



REV.	DESCRIPTION	NAME	DATE
A	NEWS ISSUE		

特性:

一、电气性能: ELECTRICAL

1. 额定电流: 3.0A
2. 接触阻抗: 40 MILLIOHMS MAX
3. 耐电压: 100V AC / 1 mA MAX
4. 绝缘阻抗: 100V DC/100 MEGA OHMS MIN

二、机械性能:

1. 插入力: 5~20N
2. 拨出力: 8~20N
3. 使用寿命: 3000次、拔出力 5N MIN

三、材料: MATERIAL

1. 塑胶: LCP UL94V-0
2. 端子: C2680 T=0.20MM
3. 外壳: SUS201 T=0.30MM
4. 卡勾: SUS301 T=0.20MM

四、电镀: FINISH

1. 端子: 接触点镀金10~MIN, PIN脚焊接区域镀锡500~MIN.
2. 外壳: 镀镍500~MIN (盐雾48H)

五、电镀品需做粘锡测试: 粘锡面积达到95%以上。

六、SMT回流焊 (峰值260° C±5° C) 不能起泡、熔胶、变色不良 (变形在公差范围以内)

七、工作温度: -40° C~+85° C

八、盐雾测试: 通过48H在浓度为5±1%盐水的盐雾测试无生锈现象

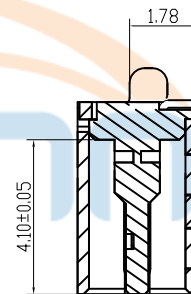
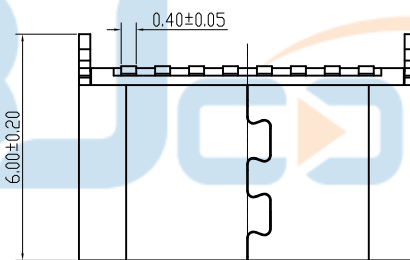
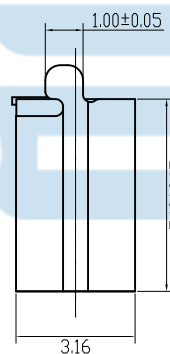
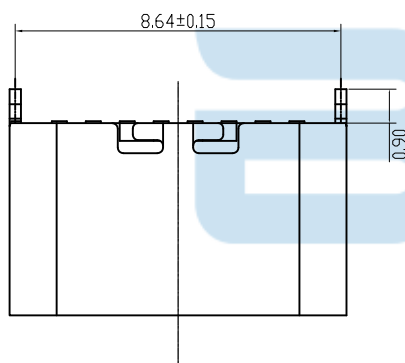

USB TYPE-C PIN ASSIGNMENTS

PIN NUMBER	A1	A2	A3	A4	A5	A6	A7	A8	A9	A10	A11	A12
SIGNAL NAME	GND	SSTXp1	SSTXn1	Vbus	CC1	Dp1	Dn1	SBU1	Vbus	SSRXn2	SSRXp2	GND
PIN NUMBER	B12	B11	B10	B9	B8	B7	B6	B5	B4	B3	B2	B1
SIGNAL NAME	GND	SSRXp1	SSRXn1	Vbus	SBU2	Dn2	Dp2	CC2	Vbus	SSTXn2	SSTXp2	GND

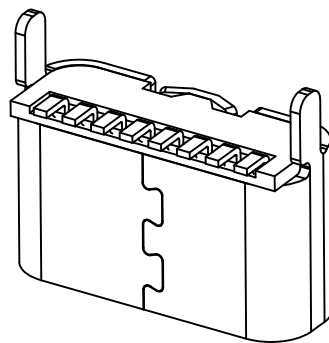
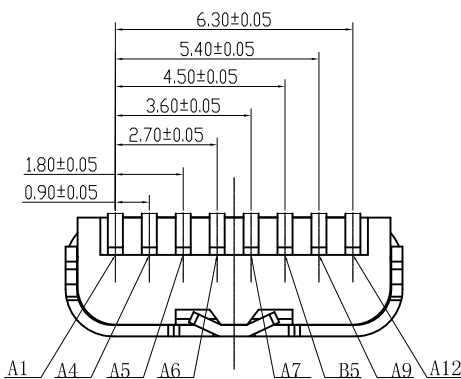

TOLERANCE UNSPECIFIED

.0	±0.35
.00	±0.25
.000	±0.15
X. °	±2.00°

CUSTOMER DRAWING



深圳市步步精科技有限公司

TITLE: TYPE-C 8P 母座 直立式 H=5.10 两脚插 端子SMT

DRAWN/ DATE	设计 TSP	SIZE:A4	UNIT:MM.	PART. NO:	126-224-080001-H8G
CHECKED/ DATE	审核 LYX	SCALE: 1:1	PROJECTION	REV.:	版本
APPROVED/ DATE	核准 LJP	DWG. PATH	0482-1	SHEET:	页码



REV.	DESCRIPTION	NAME	DATE
A	NEWS ISSUE		

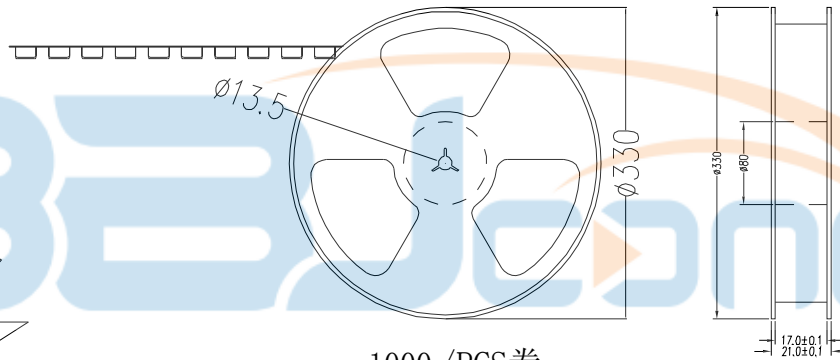
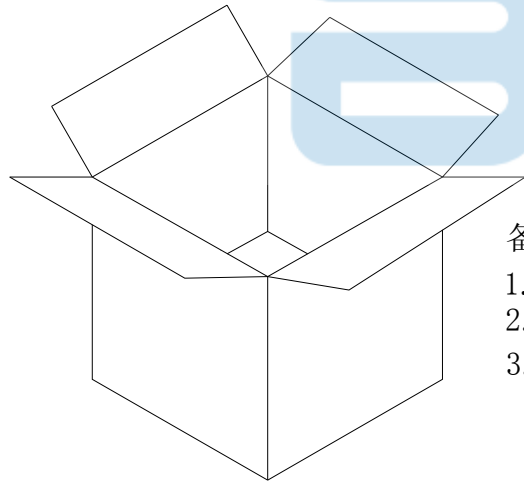
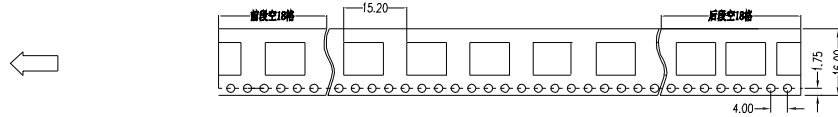
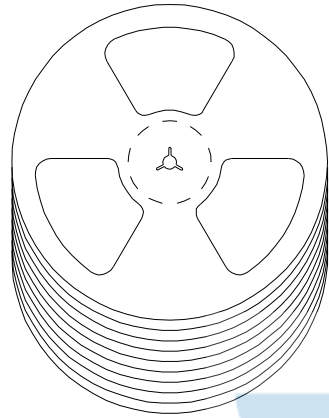

1000 / PCS 卷



备注:

1. 包装数量: 1000 / PCS / 卷, 10卷 / 箱或15卷 / 箱。
2. 包装袋长度: 每卷前后各空10-20个空格, 中间包装。

3. 材质:

载体: 聚丙烯 (PS), 阻抗 $10^{6-9} \Omega$

上带: 聚乙烯 (PET), 阻抗 $10^{6-11} \Omega$

卷盘: 聚苯乙烯。

纸箱规格: 345*345*23MM

纸箱规格: 345*345*35MM

TOLERANCE UNSPECIFIED		深圳市步步精科技有限公司 TITLE: TYPE-C 8P 母座 直立式 H=5.10 两脚插 端子SMT	
.0	±0.35		
.00	±0.25	DRAWN/ DATE 设计 TSP SIZE:A4 UNIT:MM. PART. NO: 126-224-080001-H8G	
.000	±0.15	CHECKED/ DATE 审核 LYX SCALE: 1:1 PROJECTION REV.: 版本	
X. °	±2.00°	APPROVED/ DATE 核准 LJP DWG. PATH 0482-1 SHEET: 页码	
CUSTOMER DRAWING			