

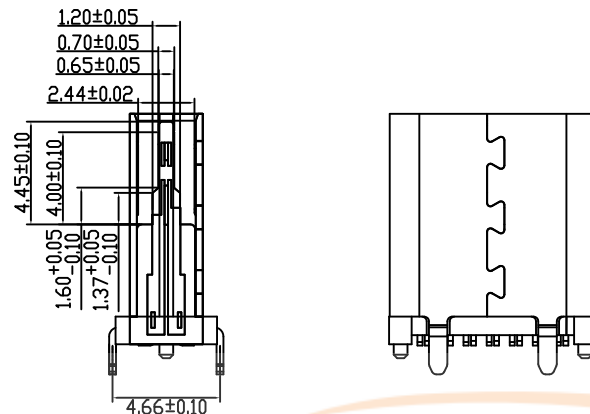

REV.	DESCRIPTION	NAME	DATE
A	NEWS ISSUE		

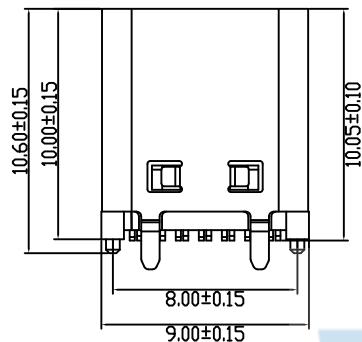

截面 1-1

SPECIFICATIONS:

- ELECTRICAL CHARACTERISTICS:
  - CONTACT RESISTANCE: 30mΩ MAX.
  - DIELECTRIC WITHSTANDING VOLTAGE: 100V AC FOR ONE MINUTE.
  - INSULATION RESISTANCE: 100MΩ MIN. MEASURED BY 500 VDC
- MECHANICAL CHARACTERISTICS:
  - INSERTION FORCE :0.5-2.0KgF(REF.)
  - WITHDRAWAL FORCE :0.8-2.0KgF(REF.)
- LIFE TEST: 10,000 CYCLES.

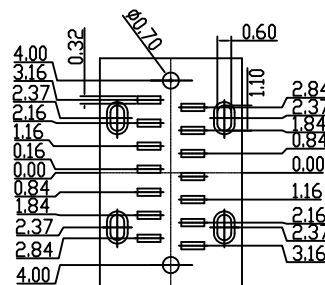
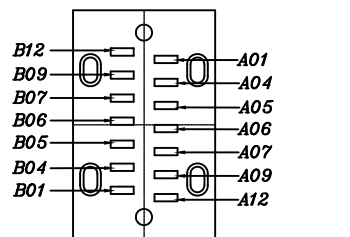
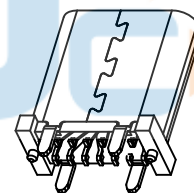
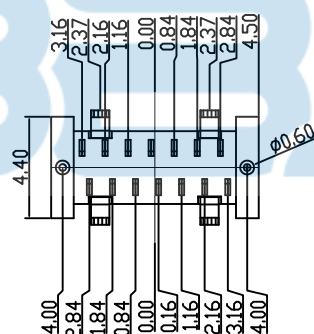
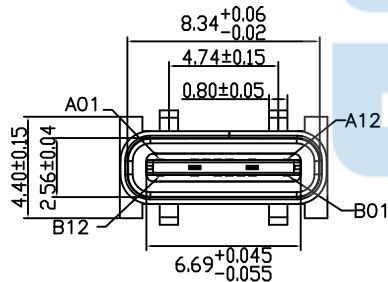

RECOMMENDED P.C.B. LAYOUT (T:1.00mm)  
TOLERANCE UNSPECIFIED ±0.05mm

USB TYPE-C PIN ASSIGNMENTS

PIN NUMBER	A1	A2	A3	A4	A5	A6	A7	A8	A9	A10	A11	A12
SIGNAL NAME	GND			Vbus	CC1	Dp1	Dn1		Vbus			GND
PIN NUMBER	B12	B11	B10	B9	B8	B7	B6	B5	B4	B3	B2	B1
SIGNAL NAME	GND			Vbus		Dn2	Dp2	CC2	Vbus			GND

NO.	DESCRIPTION	MATERIAL	REMARKS	QTY
6	SHELL	STAINLESS STEEL	Ni Plated	1PCS
5	SHIELDING PLATE	STAINLESS STEEL	---	1PCS
4	MD	HIGH TEMPERATURE PLASTIC	BLACK/WHITE	1PCS
3	CONTACT	COPPER ALLOY	Au/Ni Plated	1SET
2	CONTACT	COPPER ALLOY	Au/Ni Plated	1SET
1	HOUSING	HIGH TEMPERATURE PLASTIC	BLACK/WHITE	1PCS

公差尺寸表

Tolerance	X	X'	X''
X	±0.50	X' ± 2'	
X	±0.30	X' ± 1'	
XX	±0.10	XX' ± 0.5'	
XXX	±0.05		

深圳市步步精科技有限公司

TITLE:  
TYPE-C 14PIN母座 直立贴片SMT 直脚 H=10.0mm 加盖 白胶 编带

DRAWN/ DATE	设计 LYX	SIZE:A4	UNIT:MM.	PART. NO:	126-224-140001-H8G
CHECKED/ DATE	审核 HMY	SCALE: 1:1	PROJECTION	REV.:	版本
APPROVED/ DATE	核准 LJP	DWG. PATH	0482-1	SHEET:	页码

REV.	DESCRIPTION	NAME	DATE
A	NEWS ISSUE		

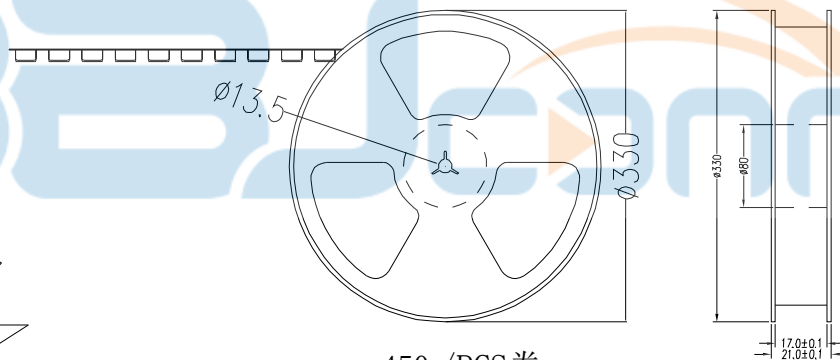
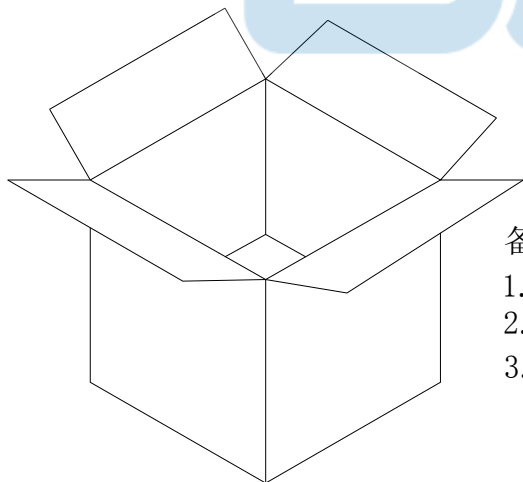
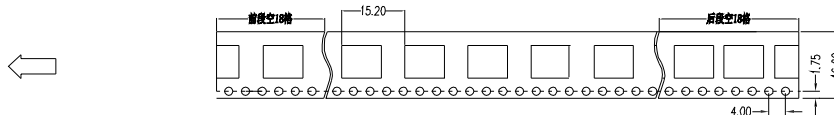
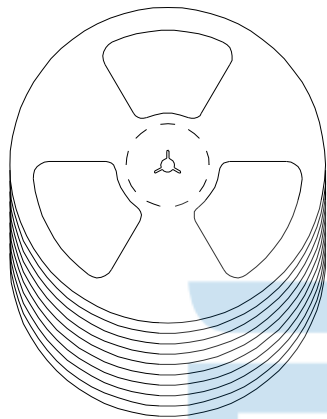

450 /PCS卷

备注:

1. 包装数量: 450 /PCS/卷, 10卷/箱或15卷/箱。
2. 包装袋长度: 每卷前后各空10-20个空格, 中间包装。
3. 材质:  
 载体: 聚丙烯 (PS), 阻抗 $10^{6-9} \Omega$   
 上带: 聚乙烯 (PET), 阻抗 $10^{6-11} \Omega$   
 卷盘: 聚苯乙烯。

纸箱规格: 345\*345\*23MM

纸箱规格: 345\*345\*35MM



TOLERANCE	UNSPECIFIED
.0	±0.35
.00	±0.25
.000	±0.15
X. °	±2.00°

**BBJconn** 深圳市步步精科技有限公司

TITLE:  
TYPE-C 14PIN母座 直立式贴片SMT 直脚 H=10.0mm 加盖 白胶 编带

DRAWN/ DATE	设计 LYX	SIZE:A4	UNIT:MM.	PART.NO: 126-224-140001-H8G
CHECKED/ DATE	审核 HMY	SCALE: 1:1	PROJECTION	REV.: 版本
APPROVED/ DATE	核准 LJP	DWG. PATH	0482-1	SHEET: 页码