

REV	ECN NO	CONTENT	DATE	ENGINEER
A0		INITIAL RELEASE	/	SGF

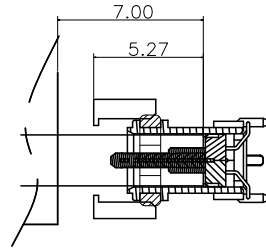

PLUG插入深度参考图

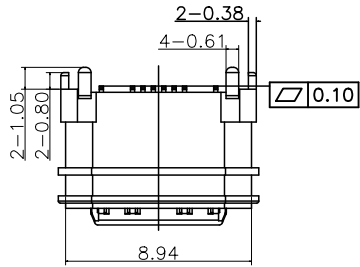
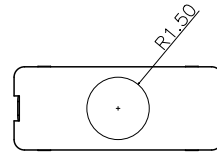

特性:

- 一、电气性能: ELECTRICAL
 1. 额定电流: 5.0A
 2. 接触阻抗: 40 MILLIOHMS MAX
 3. 耐电压: 100V AC / 1 mA MAX
 4. 绝缘阻抗: 150V DC/100 MEGA OHMS MIN
- 二、机械性能: MECHANICAL
 1. 插入力: 5~20N
 2. 拨出力: 8~20N
 3. 使用寿命: 10000次、拨出力 5N MIN
- 三、材料: MATERIAL
 1. 外壳: 粉末冶金
 2. 胶芯: LCP UL94 V-0
 3. 端子: C7025
 4. 卡勾: 不锈钢
- 四、电镀: FINISH
 1. 端子: 接触点镀金1U~MIN
PIN脚焊接区域镀锡80U~MIN
 2. 外壳: 镀镍50U~MIN (盐雾48H)
- 五、电镀品需做粘锡测试: 粘锡面积达到95%以上。
- 六、SMT回流焊 (峰值260° C±5° C) 不能起泡、熔胶、变色不良 (变形在公差范围以内)
- 七、工作温度: -55° C~+85° C
- 八、盐雾测试: 通过48H在浓度为5±1%盐水的盐雾测试无生锈现象。

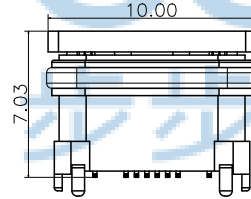
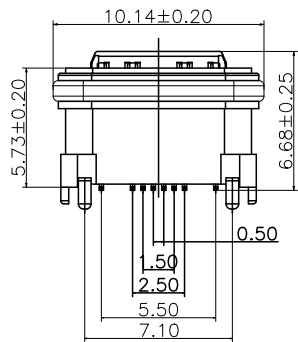
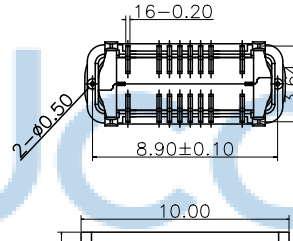
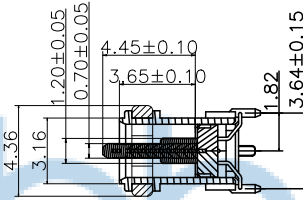
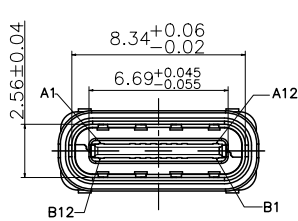

Added suction cover view

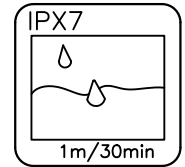
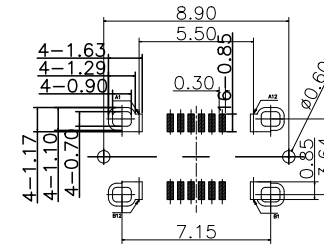

机壳与胶圈干涉建议单边0.15最小, 胶圈尺寸跑上限.

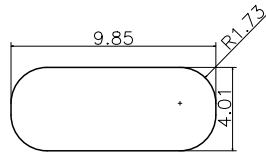
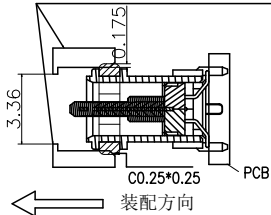

组装示意图

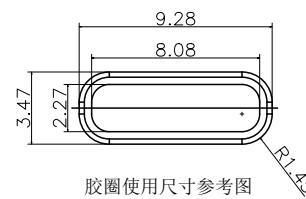

胶圈使用尺寸参考图

RECOMMENDED P.C.B. LAYOUT (T:1.00mm)
TOLERANCE UNSPECIFIED ±0.05mm



开孔尺寸参考
组装外壳时需要打环润滑油
USB TYPE-C PIN ASSIGNMENTS

PIN NUMBER	A1	A2	A3	A4	A5	A6	A7	A8	A9	A10	A11	A12
SIGNAL NAME	GND			Vbus	CC1	Dp1	Dn1	SBU1	Vbus			GND
PIN NUMBER	B12	B11	B10	B9	B8	B7	B6	B5	B4	B3	B2	B1
SIGNAL NAME	GND			Vbus	SBU2	Dn2	Dp2	CC2	Vbus			GND

THIS DOCUMENT IS THE
SOLE PROPERTY OF
BBJconn Technology Co.,Ltd.
Corporation AND SHOULD
NOT BE USED IN WHOLE
PRIOR WRITTEN PERMISSION.
PDWG NO: 0482-1

深圳市步步精科技有限公司

NAME: TYPE-C 16P 防水母座 立贴 四脚插 端子
SMT 舌片外露0.8 H=5.73 IPX7 编带

PJ NO: 126-224-160004-H8G

SIZE:A4 DRW NO:

FINISH:SEE NOTES MAT'L:SEE NOTES

SCALE:N/A REV:A0 UNIT:mm PAGE:1/2

REV	ECN NO	CONTENT	DATE	ENGINEER
AO		INITIAL RELEASE	/	SGF

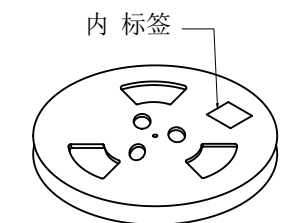
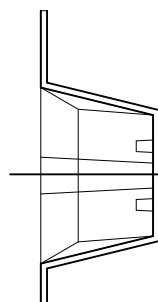
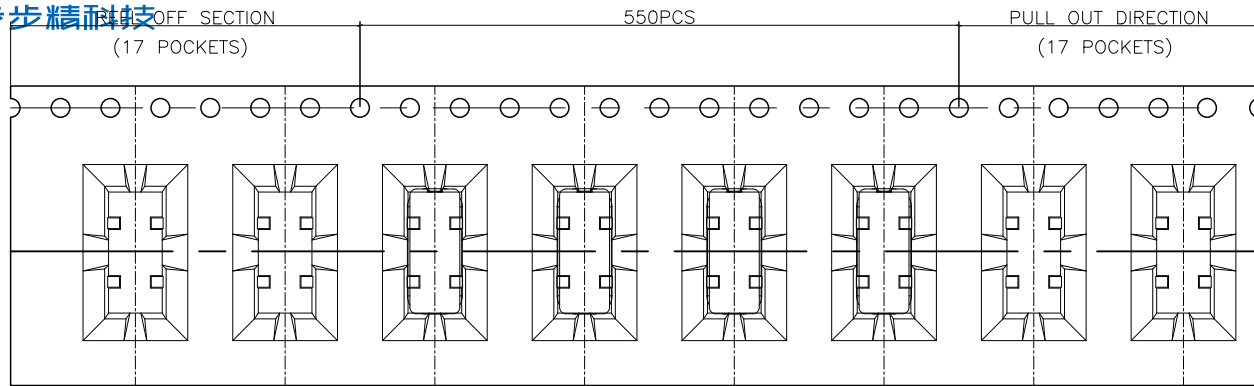

② 卷盘贴标签示意图

① 产品入载带示意图

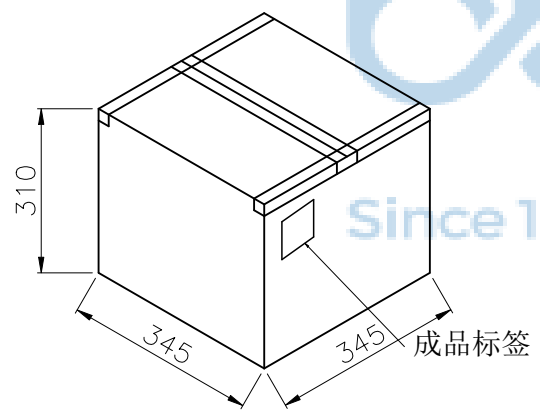

⑤ 外箱封箱示意图

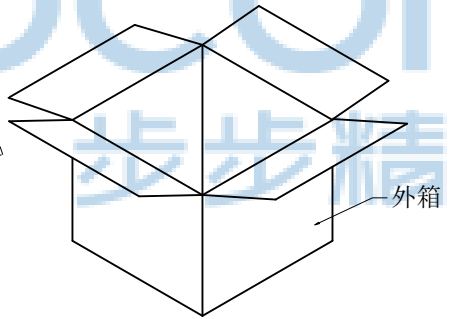

④ 产品入外箱示意图

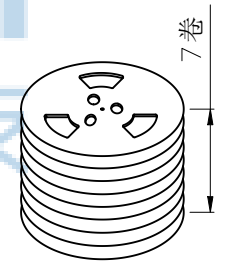

③ 7盘产品叠层示意图



包装说明:

1. 将检验好的成品;对插口朝前放入载带;每卷装550PCS产品;具体如图一所示
2. 将包装好的产品;每盘必需贴上内标签;具体如图二所示
3. 将贴好内标签的产品每7盘叠;具体如图三所示
5. 装好后并封好纸箱及贴好相关标签;具体如图五所示;
(产品包装的标签,如客户有要求,请按客户要求包装出货)
6. 载带前面留17PCS空格,后面留17PCS空格
7. COVER与CARRY剥离力:50-125g,速度:300mm/分钟左右,剥离角度:165°-180°

	REEL	CARTON
CONNECTOR (PCS)	550	3850

THIS DOCUMENT IS THE SOLE PROPERTY OF BBJconn Technology Co.,Ltd. Corporation AND SHOULD NOT BE USED IN WHOLE PRIOR WRITTEN PERMISSION. PDWG NO: 0482-1		深圳市步步精科技有限公司 .X: ±0.38 .XX: ±0.25 .XXX: ±0.13 X': ±3' .X': ±2' .XX': ±1'		NAME: TYPE-C 16P 防水母座 立贴 四脚插 端子 SMT 舌片外露0.8 H=5.73 IPX7 编带 PJ NO: 126-224-160004-H8G SIZE:A4 DRW NO: FINISH:SEE NOTES MAT'L:SEE NOTES SCALE:N/A REV:AO UNIT:mm PAGE:2/2	
APPD	JM_Zheng				
CHKD	LYX				
DR	SGF				