

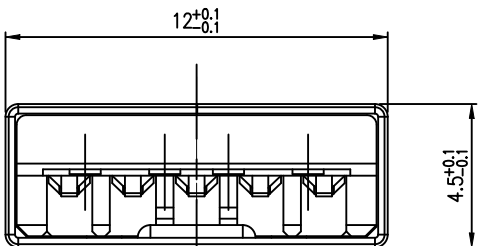

REV.	ECN NO	CONTENT	DATE	ENGINEER
AO		Initial release	/	TSP

NOTE:

- MATERIAL:
 - INSULATOR: HIGH TEMPERATURE PLASTIC LCP;
 - CONTACT: COPPER ALLOY (T=0.20mm)
 - SHELL: SPCC1 (T=0.30mm)
- ELECTRICAL CHARACTERISTICS:
 - CONTACT RESISTANCE: 30mΩ Max
 - CONTACT CURRENT RATING: 1.5A
 - DIELECTRIC WITHSTANDING VOLTAGE: 100 V R. M. S.
 - INSULATION RESISTANCE 100 MEGOHMS Min
 - OPERATING TEMPERATURE: -25° C ~ 75° C
- MECHANICAL CHARACTERISTICS:
 - MATING FORCE: 35 N Max
 - UNMATED FORCE: 10 N Min
- PLATING
 - TERMINAL CONTACT: (SEE TAB) GOLD PLATING ALL OVER 50u"MIN NICKEL AND 80u"MIN Tin ALL OVER 50u" MIN NICKEL ON SOLDER AREA
 - SHELL: 50u"MIN. NICKEL ALL OVER
 - DURABILITY: MANDATORY: 3000 CYCLES

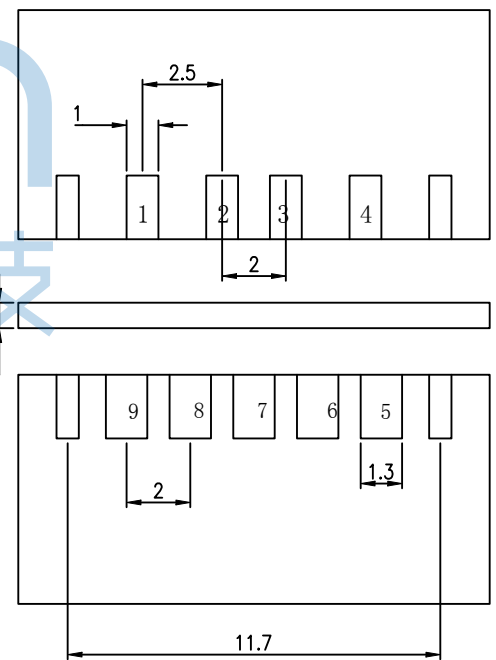
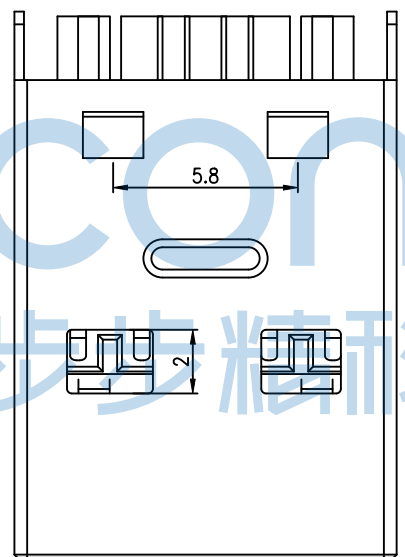
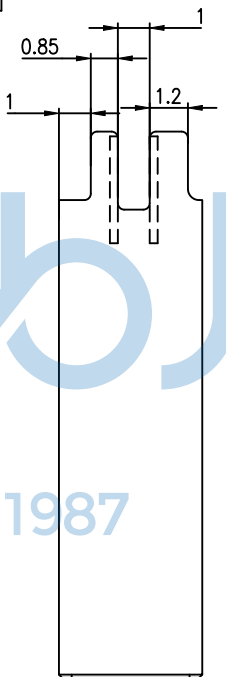
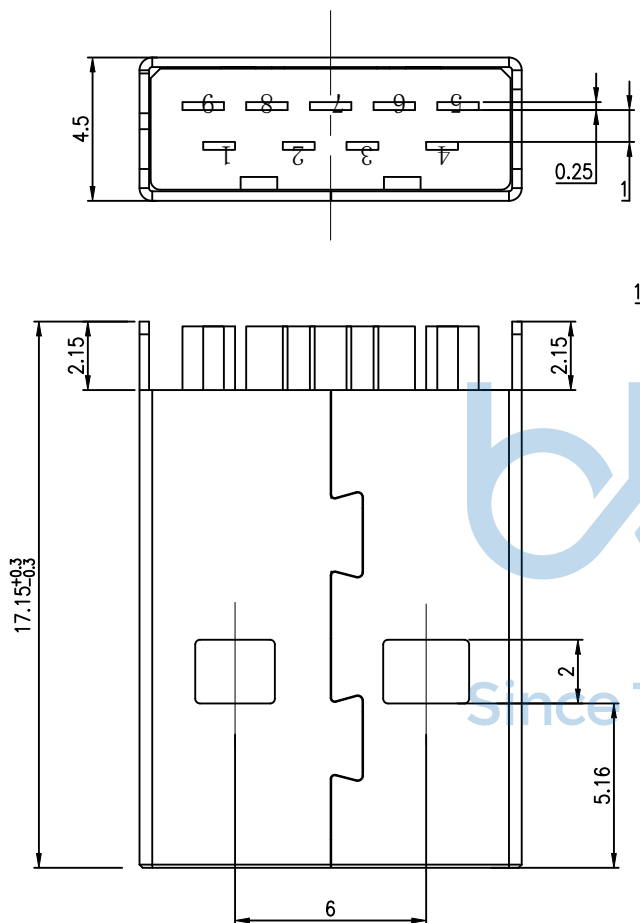

Pin NUMBER	SIGNAL NAME
1	VBUS
2	D-
3	D+
4	GND
5	StdA_SSRX-
6	StdA_SSRX+
7	GND_DRAIN
8	StdA_SSTX-
9	StdA_SSTX+
Shell	Shield



THIS DOCUMENT IS THE SOLE PROPERTY OF BBJconn Technology Co., Ltd. Corporation AND SHOULD NOT BE USED IN WHOLE OR IN PART WITHOUT PRIOR WRITTEN PERMISSION.

PDWG.NO: 0471-1

APPD. JM_Zheng
CHKD. LYX
DR. TSP

深圳市步步精科技有限公司

NAME: USB 3.0 公头 180度 H=15.0 夹板1.0 平口 LCP蓝胶 铁壳

PJ. NO.: UB.04.62-31-W001
SIZE: A4 DRW NO.:

FINISH: SEE NOTES MAT'L.: SEE NOTES
SCALE: N/A REV.: AO UNIT: mm PAGE: 1/2

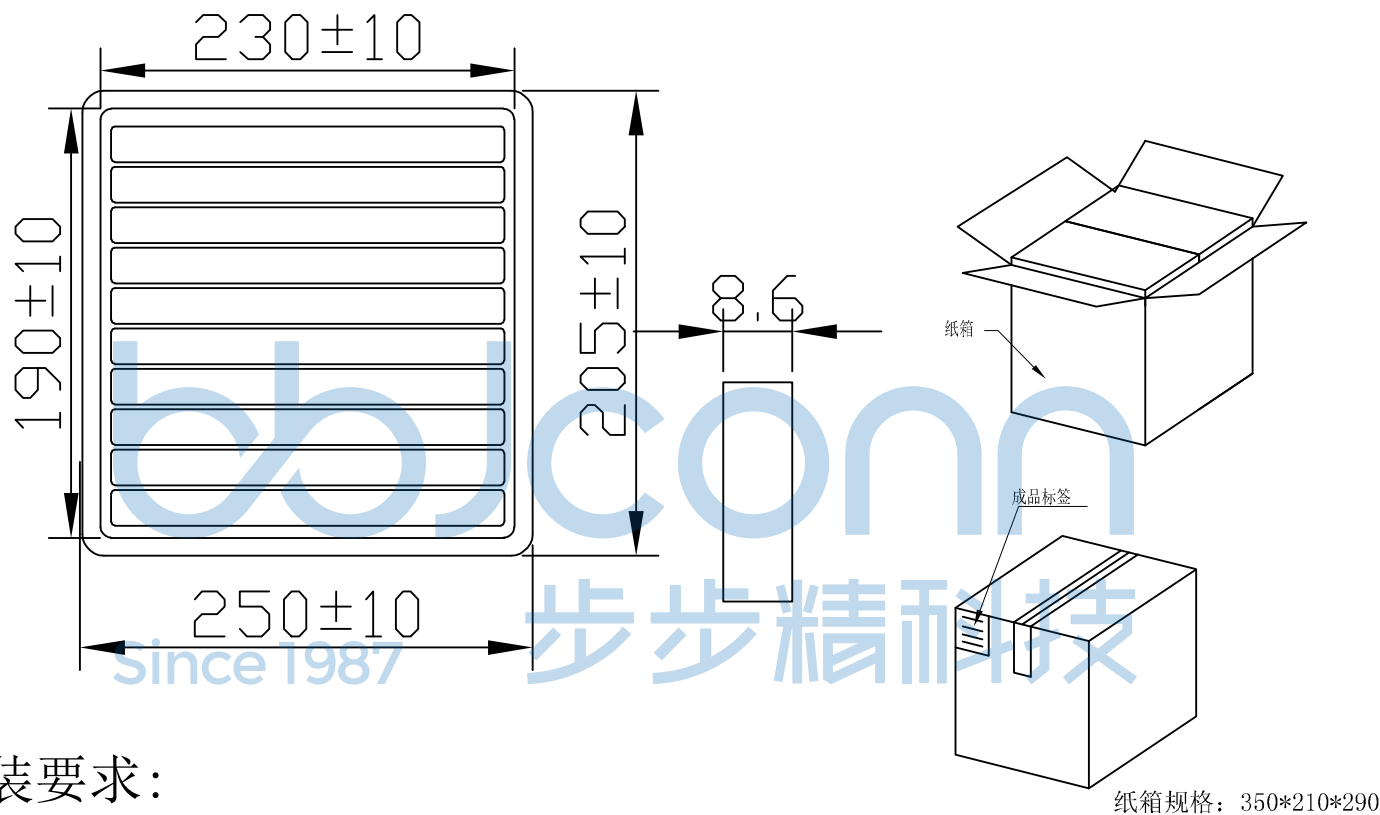

1. 包装要求:
- 1.1 每盒吸塑盒包装100pcs;
 - 1.2 每20盘放一箱, 共计2000PCS;
 - 1.3 纸箱外贴上标签。

THIS DOCUMENT IS THE SOLE PROPERTY OF BBJconn Technology Co.,Ltd. Corporation AND SHOULD NOT BE USED IN WHOLE OR IN PART WITHOUT PRIOR WRITTEN PERMISSION.		 深圳市步步精科技有限公司	
PDWG.NO: 0471-1		.X: ±0.38 .XX: ±0.25 .XXX: ±0.13	X*: ±3" .X*: ±2" .XX*: ±1"
APPD.	JM_Zheng	NAME: USB 3.0 公头 180度 H=15.0 夹板1.0 平口 LCP蓝胶 铁壳	
CHKD.	LYX	PJ. NO.: UB.04.62-31-W001	
DR.	TSP	SIZE: A4 DRW NO.:	
		FINISH: SEE NOTES MAT'L.: SEE NOTES	
		SCALE: N/A	REV.: A0 UNIT: mm PAGE: 2/2