

REV.	ECN NO	CONTENT	DATE	ENGINEER
A0		Initial release	/	GZY

NOTE:

A. MATERIAL:

1. HOUSING: PBT/PA9T
2. COVER: PBT/PA9T
3. CONTACT: COPPER ALLOY
4. SHELL: SUS201
5. MIDDLE SPRING: SUS201

B. PLATING:

1. CONTACT: CONTACT AREA GOLD PLATED
SOLDER AREA TIN(80u"MIN) PLATED
UNDER PLATED NICKEL(30u"MIN)
2. SHELL: NICKEL(40u"MIN) PLATED

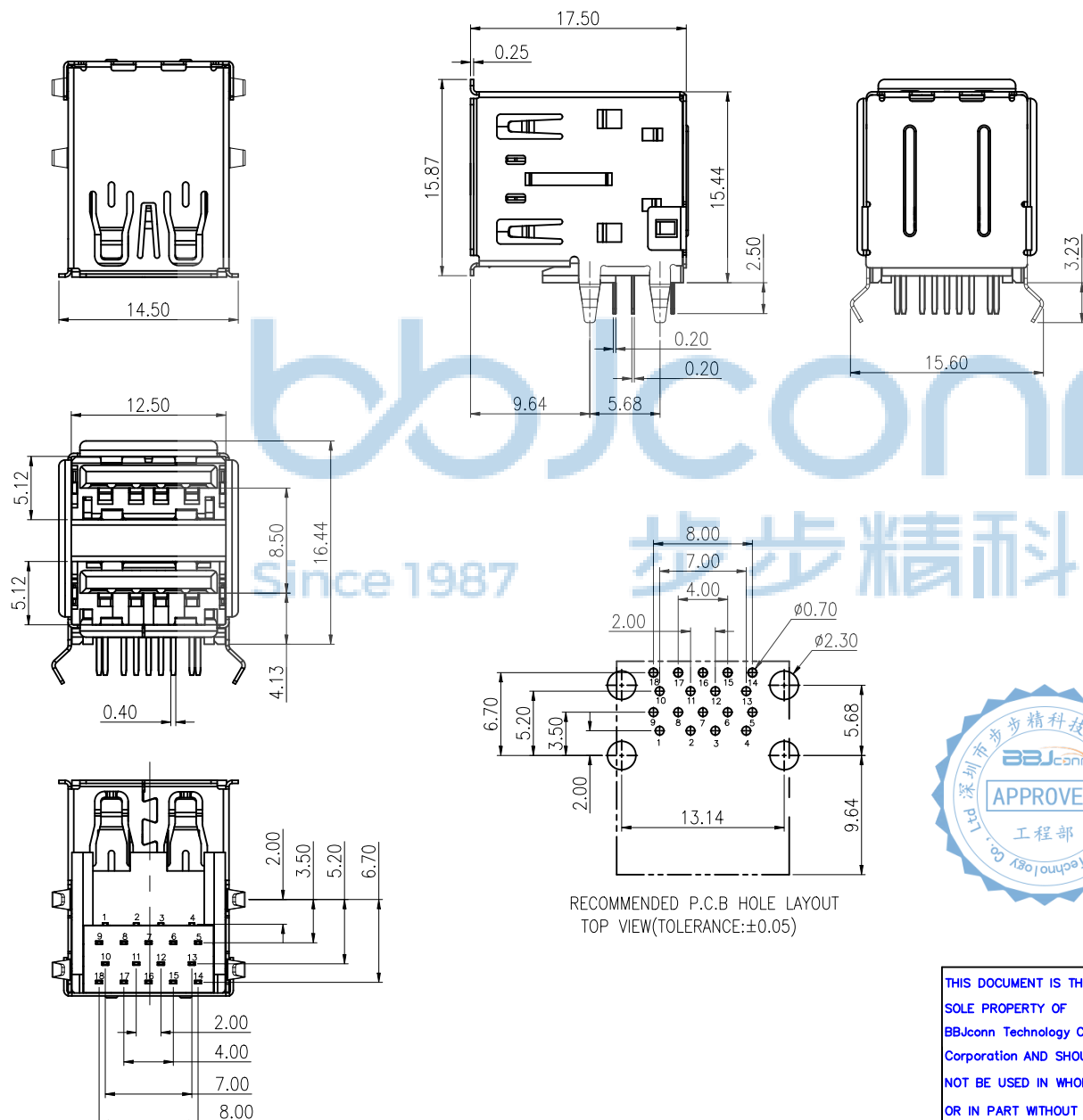

RECOMMENDED P.C.B HOLE LAYOUT
TOP VIEW(TOLERANCE:±0.05)

Pin NO.	Signal Assignment	Pin NO.	Signal Assignment
# 1	VBUS	# 10	VBUS
# 2	D-	# 11	D-
# 3	D+	# 12	D+
# 4	GND	# 13	GND
# 5	Stda_SSR-	# 14	Stda_SSR-
# 6	Stda_SSR+	# 15	Stda_SSR+
# 7	GND_DRAIN	# 16	GND_DRAIN
# 8	Stda_SST-	# 17	Stda_SST-
# 9	Stda_SST+	# 18	Stda_SST+

THIS DOCUMENT IS THE SOLE PROPERTY OF BBJconn Technology Co.,Ltd. Corporation AND SHOULD NOT BE USED IN WHOLE OR IN PART WITHOUT PRIOR WRITTEN PERMISSION. PDWG.NO: 0536-1		深圳市步步精科技有限公司	
.X: ±0.38 .XX: ±0.25 .XXX: ±0.13		X*: ±3* X*: ±2* XX*: ±1*	
APPD. JM_Zheng		NAME: USB 3.1 AF 90度 DIP 双层 L=17.46 H=15.44 四脚插 弯脚 卷边 9T蓝胶 不锈钢壳 盒装	
CHKD. LYX		PJ. NO.: 127-272-090016-P2G SIZE: A4 DRW NO.:	
DR. GZY		FINISH: SEE NOTES MAT'L.: SEE NOTES	
		SCALE: N/A REV.: A0 UNIT: mm PAGE: 1/2	

REV.	ECN NO	CONTENT	DATE	ENGINEER
AO		Initial release	/	GZY



书钉 (6PCS)

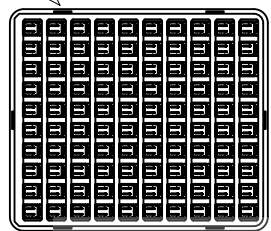

(三)
盖顶盒-打书钉

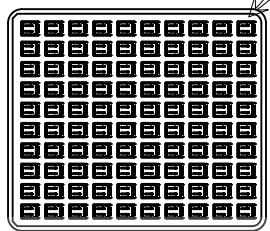

(二)
放置产品 (100PCS/盘)

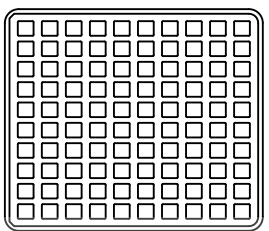

真空盘底盒: 275X235X10.2mm

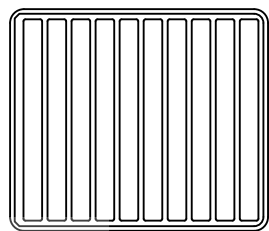

真空盘上盖: 275X235X20.3mm



内盘标签

PE膜捆扎二字型
不能把吸塑盒缠变形

透明封箱胶

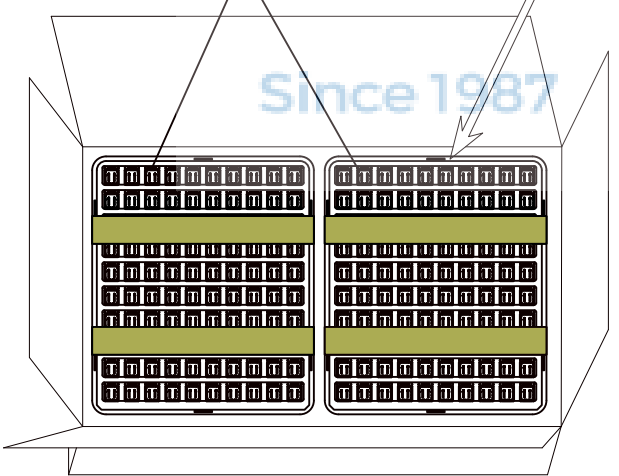

(四)

10盘一叠, 用PE膜捆扎紧, 装入外箱
左右各一捆, 一共20盘。
外箱规格: 485X295X210mm

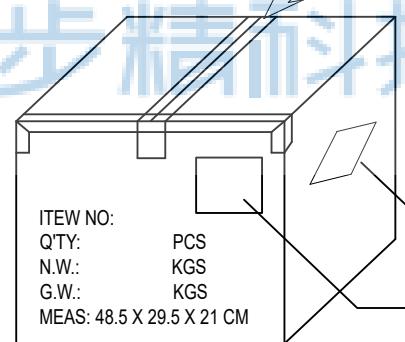

(五)
封装

ITW NO:
QTY: PCS
N.W.: KGS
G.W.: KGS
MEAS: 48.5 X 29.5 X 21 CM

外箱唛头标签

外箱标签

包装注意事项:

1. 每10叠真空盘需用PE膜作十字型捆扎;
2. 每箱需放入适量干燥剂;
3. 产品标签上需标明产品品名和料号, 及数量;
4. 尾数箱请将内部多余的空间用干燥物填满, 并在产品标签上标明尾数箱;



THIS DOCUMENT IS THE SOLE PROPERTY OF BBJconn Technology Co., Ltd. Corporation AND SHOULD NOT BE USED IN WHOLE OR IN PART WITHOUT PRIOR WRITTEN PERMISSION. PDWG.NO: 0536-1		深圳市步步精科技有限公司	
.X: ±0.38 .XX: ±0.25 .XXX: ±0.13		X*: ±3* .X*: ±2* .XX*: ±1*	
NAME: USB 3.1 AF 90度 DIP 双层 L=17.46 H=15.44 四脚插 弯脚 卷边 9T蓝胶 不锈钢壳 盒装		PJ. NO.: 127-272-090016-P2G SIZE: A4 DRW NO.: FINISH: SEE NOTES MAT'L.: SEE NOTES	
APPD. JM_Zheng	CHKD. LYX	DR. GZY	SCALE: N/A REV.: AO UNIT: mm PAGE: 2 / 2